

YAMAHA DSP-A595



BGR T

DSP-A595

Natural Sound AV Amplifier

Amplificateur audiovisuel

**OWNER'S MANUAL
MODE D'EMPLOI
BEDIENUNGSANLEITUNG
BRUKSANVISNING
MANUALE DI ISTRUZIONI
MANUAL DE INSTRUCCIONES
GEBRUIKSAANWIJZING**

SUPPLIED ACCESSORIES
ACCESSOIRES FOURNIS
MITGELIEFERTE ZUBEHÖRTEILE
MEDFÖLJANDE TILLBEHÖR
ACCESSORI IN DOTAZIONE
ACCESORIOS INCLUIDOS
BIJGELEVERDE ACCESSOIRES

- After unpacking, check that the following parts are included.
- Après le déballage, vérifier que les pièces suivantes sont incluses.
- Nach dem Auspacken überprüfen, ob die folgenden Teile vorhanden sind.
- Kontrollera efter det apparaten packats upp att följande delar finns med.
- Verificare che tutte le parti seguenti siano contenute nell'imballaggio dell'apparecchio.
- Desembalar el aparato y verificar que los siguientes accesorios están en la caja.
- Controleer na het uitpakken of de volgende onderdelen voorhanden zijn.

- Batteries (size AA, R6, UM-3)
- Piles (taille AA, R6, UM-3)
- Batterien (Größe AA, R6, UM-3)
- Batterier (storlek AA, R6, UM-3)
- Batterie (dimensioni AA, R6, UM-3)
- Pilas (tamaño AA, R6, UM-3)
- Batterijen (maat AA, R6, UM-3)

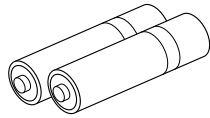

- Remote control transmitter
- Télécommande
- Fernbedienung
- Fjärrkontroll
- Telecomando
- Transmisor de control remoto
- Afstandsbediening

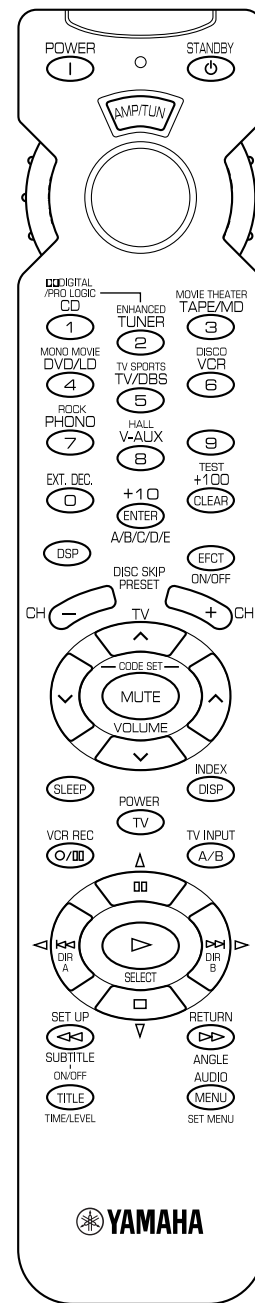



FEATURES

- **5 Speaker Configuration**
 - Main: 65 W + 65 W (8Ω) RMS Output**
Power, 0.04% THD, 20 Hz – 20 kHz
 - Center: 65 W (8Ω) RMS Output**
Power, 0.04% THD, 20 Hz – 20 kHz
 - Rear: 65 W + 65 W (8Ω) RMS Output**
Power, 0.04% THD, 20 Hz – 20 kHz
- **Digital Sound Field Processor**
- **Dolby Digital Decoder**
- **Dolby Pro Logic Surround Decoder**
- **CINEMA DSP: Theater-like Sound Experience by the Combination of Dolby Surround and YAMAHA DSP Technology**
- **6-Channel External Decoder Input for DTS and other future formats**
- **Automatic Input Balance Control for Dolby Pro Logic Surround**
- **Test Tone Generator for Easier Speaker Balance Adjustment**
- **Speaker Output Mode Changing Capability**
- **Video Signal Input/Output Capability (Including S Video Connections)**
- **SLEEP Timer**
- **Universal Remote Control Transmitter with Preset Manufacturer Codes**

CONTENTS

SUPPLIED ACCESSORIES	2	● Information about DSP	
FEATURES	3	USING DIGITAL SOUND FIELD	
CAUTION	4	PROCESSOR (DSP)	29
● Introduction		● Advanced Information	
FEATURES ON SOUND EFFECT	5	ADJUSTMENTS	
CONTROLS AND THEIR FUNCTIONS	7	IN THE "SET MENU" MODE	35
● Preparation		● Remote Control Transmitter	
SPEAKER SETUP	10	REMOTE CONTROL TRANSMITTER	37
CONNECTIONS	12	SETUP CODES	42
ADJUSTMENTS		NOTES ABOUT THE REMOTE CONTROL	
BEFORE USING THIS UNIT	19	TRANSMITTER	43
● Basic Operation		TROUBLESHOOTING	44
BASIC OPERATIONS	24	SPECIFICATIONS	46
SETTING THE SLEEP TIMER	28	LIST OF MANUFACTURER'S CODE	311

CAUTION : READ THIS BEFORE OPERATING YOUR UNIT.

1. To assure the finest performance, please read this manual carefully. Keep it in a safe place for future reference.
2. Install this unit in a cool, dry, clean place – away from windows, heat sources, sources of excessive vibration, dust, moisture and cold. Avoid sources of humming (transformers, motors). To prevent fire or electrical shock, do not expose the unit to rain or water.
3. Never open the cabinet. If something drops into the set, contact your dealer.
4. Do not use force on switches, controls or connection wires. When moving the unit, first disconnect the power plug and the wires connected to other equipment. Never pull the wires themselves.
5. The openings on the unit cover assure proper ventilation of the unit. If these openings are obstructed, the temperature inside the unit will rise rapidly. Therefore, avoid placing objects against these openings, and install the unit in a well-ventilated area to prevent fire and damage.
<U.K. and Europe models>
Be sure to allow a space of at least 20 cm behind, 20 cm on the both sides and 30 cm above the top panel of the unit to prevent fire and damage.
6. The voltage used must be the same as that specified on this unit. Using this unit with a higher voltage than specified is dangerous and may result in fire or other accidents. YAMAHA will not be held responsible for any damage resulting from use of this unit with a voltage other than specified.
7. Digital signals generated by this unit may interfere with other equipment such as tuners, receivers or TVs. Move this unit farther away from such equipment if interference is observed.
8. Always set the VOLUME control to “∞” before starting the audio source play. Increase the volume gradually to an appropriate level after playback has been started.
9. Do not attempt to clean the unit with chemical solvents; this might damage the finish. Use a clean, dry cloth.
10. Be sure to read the “TROUBLESHOOTING” section regarding common operating errors before concluding that the unit is faulty.
11. When not planning to use this unit for long periods of time (ie., vacation, etc.), disconnect the AC power plug from the wall outlet.
12. To prevent lightning damage, disconnect the AC power plug and disconnect the antenna cable when there is an electrical storm.
13. Grounding or polarization – Precautions should be taken so that the grounding or polarization of an appliance is not defeated.
14. AC outlet
Do not connect audio equipment to the AC outlet on the rear panel if that equipment requires more power than the outlet is rated to provide.
15. **Voltage Selector (China and General Models only)**
The voltage selector on the rear panel of this unit must be set for your local main voltage BEFORE plugging into the AC main supply.
Voltages are 110/120/220/240 V AC, 50/60 Hz.

For U.K. customers

If the socket outlets in the home are not suitable for the plug supplied with this appliance, it should be cut off and an appropriate 3 pin plug fitted. For details, refer to the instructions described below.

Note: The plug severed from the mains lead must be destroyed, as a plug with bared flexible cord is hazardous if engaged in a live socket outlet.

Special Instructions for U.K. Model

IMPORTANT

THE WIRES IN THE MAINS LEAD ARE COLOURED IN ACCORDANCE WITH THE FOLLOWING CODE:

Blue: NEUTRAL

Brown: LIVE

As the colours of the wires in the main lead of this apparatus may not correspond with the coloured markings identifying the terminals in your plug, proceed as follows:

The wire which is coloured BLUE must be connected to the terminal which is marked with the letter N or coloured BLACK. The wire which is coloured BROWN must be connected to the terminal which is marked with the letter L or coloured RED. Make sure that neither core is connected to the earth terminal of the three pin plug.

This unit is not disconnected from the AC power source as long as it is connected to the wall outlet, even if this unit itself is turned off. This state is called the standby mode. In this state, this unit is designed to consume a very small quantity of power.



FEATURES ON SOUND EFFECT

This unit incorporates a sophisticated, multi-program digital sound field processor. The processor allows you to electronically expand and change the shape of the audio sound field from both audio and video sources, creating a theater-like experience in your listening room. This unit has a total of 8 digital sound field processor (DSP) modes. You can create an excellent audio sound field by selecting a suitable sound field (this will, of course, depend on what you will be listening to), and adding desired adjustments.

Digital Sound Field Processing

What is it that makes live music so good? Today's advanced sound reproduction technology lets you get extremely close to the sound of a live performance, but chances are you'll still notice something missing, the acoustic environment of the live concert hall. Extensive research into the exact nature of the sonic reflections that create the ambience of a large hall has made it possible for YAMAHA engineers to bring you this same sound in your listening room, so you'll feel all the sound of a live concert.

Dolby Pro Logic Surround

This unit employs a Dolby Pro Logic Surround decoder similar to professional Dolby Stereo decoders used in many movie theaters. By using the Dolby Pro Logic Surround decoder, you can experience the dramatic realism and impact of Dolby Surround movie theater sound in your own home. Dolby Pro Logic employs a four channel five speaker system. The Pro Logic Surround system divides the input signal into four levels: the left and right main channels, the center channel (used for dialog), and the rear surround sound channels (used for sound effects, background noise, and other ambient noises). The center channel allows listeners seated in even less-than-ideal positions to hear the dialog originating from the action on the screen while experiencing good stereo imaging.

Dolby Digital

The built-in Dolby Digital decoder leads you into a totally new sound experiences.

Dolby Digital is a new generation of multi-channel digital audio technology, or the newest spatial sound processing format developed for 35 mm film-movies by employing a new kind of low bit-rate audio coding.

Dolby Digital is a digital surround sound system that provides completely independent multi-channel audio to consumers. In multi-channel form, Dolby Digital provides five full range channels in what is sometimes referred to as a "3/2" configuration: three front channels (left, center and right), plus two surround channels. A sixth bass-only effect channel is also provided for output of LFE (low frequency effect), or low bass effects that are independent of other channels. This channel is counted as 0.1, thus giving rise to the term 5.1 channels in total.

In addition, this unit incorporates a Dolby Pro Logic Surround decoder and Dolby Digital decoder for multi-channel sound reproduction of Dolby Surround encoded video sources. The operation of the Dolby Pro Logic Surround or Dolby Digital decoder can be controlled by selecting a corresponding DSP program including combined operations of the YAMAHA DSP and the Dolby Pro Logic Surround or Dolby Digital decoder.

Furthermore, our technicians, armed with sophisticated measuring equipment, have even made it possible to capture the acoustics of a variety of actual concert halls, theaters, etc. from around the world, to allow you to accurately re-create any one of these live performance environments, all in your home.

Dolby Surround is encoded on the sound track of pre-recorded video tapes, laser discs, and some TV/cable broadcasts. When you play a source encoded with Dolby Surround on this unit, the Dolby Pro Logic Surround decoder decodes the signal and distributes the surround-sound effects.

This Dolby Pro Logic Surround decoder employs a digital signal processing system. This system improves the stability of sound at each channel and crosstalk between channels, so that positioning of sounds around the room is more accurate compared with conventional analog signal processing systems.

In addition, this unit features a built-in automatic input balance control. This always assures you the best performance without manual adjustment.

Compared to Dolby Pro Logic that is referred to a "3/1" system (left front, center, right front and just one surround channel), Dolby Digital features two surround channels, called stereo or split surrounds, each offering the same full range fidelity as the three front channels.

Sound of wide dynamic range reproduced by the five full range channels presents listeners much excitement that has never been experienced before. Precise sound orientation by the discrete digital sound processing expands realism that the original movie possesses.

LD and DVD are home audio formats that could benefit from Dolby Digital. In the near future, Dolby Digital will also be applied to DBS, CATV and HDTV. The ongoing release of Dolby Stereo Digital theatrical films now underway will provide an immediate source of Dolby Digital encoded video software.



Manufactured under license from Dolby Laboratories Licensing Corporation. "Dolby", "Pro Logic", and the double-D symbol are trademarks of Dolby Laboratories Licensing Corporation. Copyright 1992 Dolby Laboratories, Inc. All rights reserved.

The following original functions make the surround-sound effect of Dolby Digital become the most suitable for your audio system and the listening conditions.

- Dynamic range (sound scale) of source can be changed so that it will be suitable for the listening conditions.
- Output of low bass from any channel can be assigned to either the **MAIN SPEAKERS** terminals or **SUBWOOFER** terminal to maximize system performance.
- Output of LFE can be assigned to either the **MAIN SPEAKERS** terminals or **SUBWOOFER** terminal to maximize system performance.

Dolby Surround + DSP (CINEMA DSP)

Dolby Surround sound system shows its full ability in a large movie theater, because movie sounds are originally designed to be reproduced in a large movie theater using many speakers. It is difficult to create a sound environment similar to that of a movie theater in your listening room, because the room size, materials of inside walls, the number of speakers, etc. of your listening room is much different from those of a movie theater.

YAMAHA DSP technology made it possible to present you with nearly the same sound experience as that of a large movie theater in your listening room by compensating for lack of presence and dynamics in your listening room with its original digital sound fields combined with Dolby Surround sound field.

CINEMA DSP

The YAMAHA "CINEMA DSP" logo indicates those programs are created by the combination of Dolby Surround and YAMAHA DSP technology.

Dolby Pro Logic + 2 Digital Sound Fields

Digital sound fields are created on the presence side and the rear surround side of the Dolby Pro Logic Surround-decoded sound field respectively. They create a wide acoustic environment and emphasize surround-effect in the room, letting you feel much presence as if you are watching a movie in a popular Dolby Stereo theater.

This combination is available when the sound field program **DOLBY PRO LOGIC ENHANCED/DOLBY DIGITAL ENHANCED, 70 mm MOVIE THEATER/DIGITAL MOVIE THEATER** or **TV SPORTS** is selected, and the input signal of source is analog, PCM audio or encoded with the Dolby Digital in 2-channel.

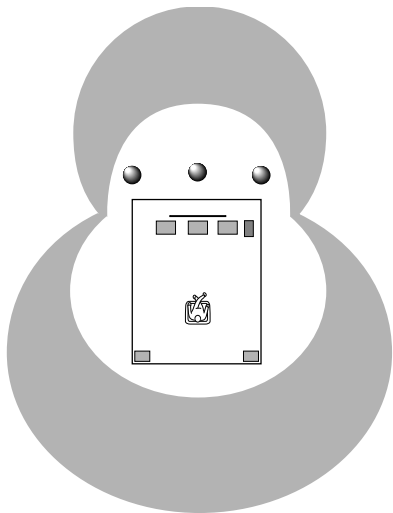

Dolby Digital + 3 Digital Sound Fields

Digital sound fields are created on the presence side and the independent left and right surround sides of the Dolby Digital-decoded sound field respectively. They create a wide acoustic environment and much surround effect in the room without losing high channel separation. With wide dynamic range of Dolby Digital sound, this sound field combination lets you feel as if you are watching a movie in the newest Dolby Stereo Digital theater. This will be the most ideal home theater sound at the present time.

This combination is available when the sound field program **DOLBY PRO LOGIC ENHANCED/DOLBY DIGITAL ENHANCED, 70 mm MOVIE THEATER/DIGITAL MOVIE THEATER** or **TV SPORTS** is selected, and the input signal of source is encoded with the Dolby Digital (except in 2-channel).

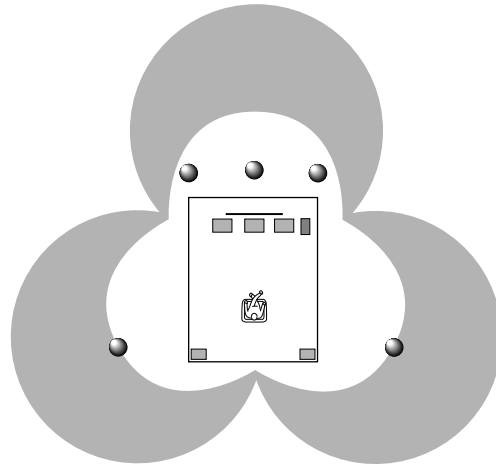

CONTROLS AND THEIR FUNCTIONS

English

FRONT PANEL

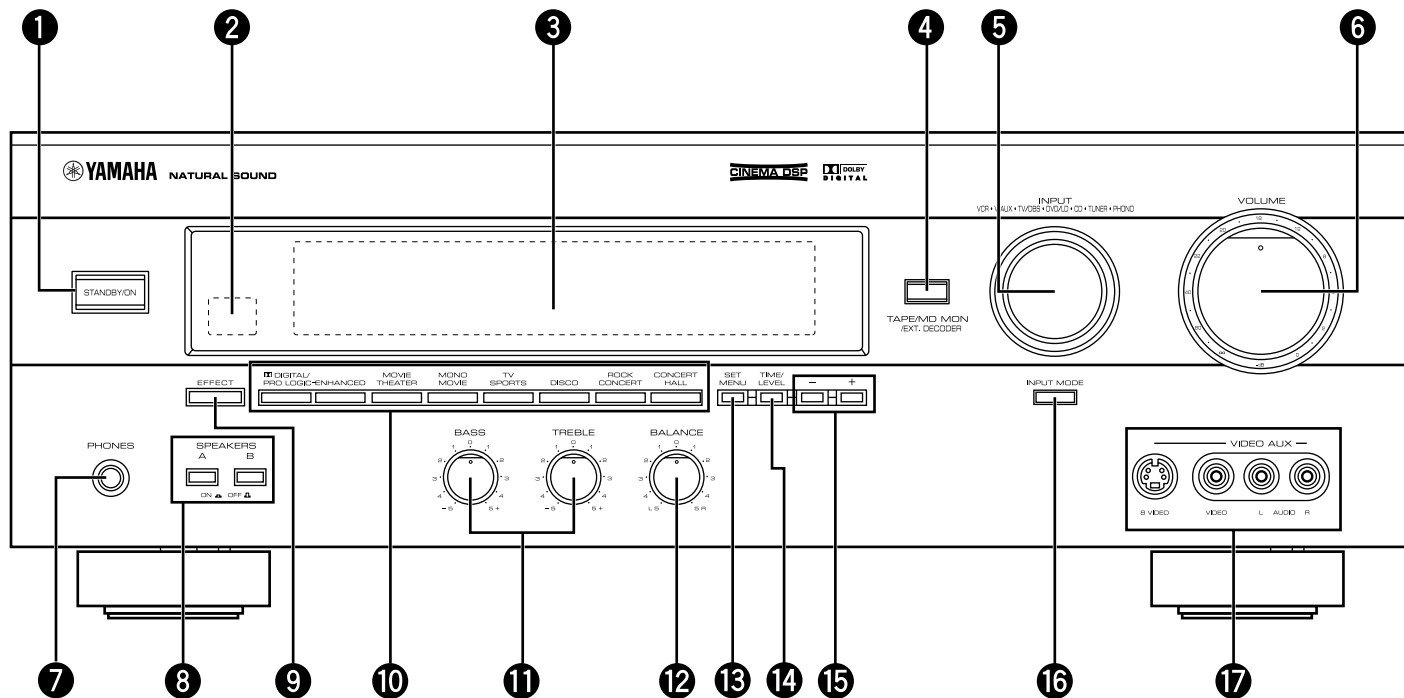

1 STANDBY/ON

Press this switch to turn the power of this unit on. Press it again to turn this unit into the standby mode.

Standby mode

In this state, this unit consumes a very small quantity of power to receive infrared-signals from the remote control transmitter.

2 Remote control sensor

Receives signals from the remote control transmitter.

3 Display

Shows various information. (For details, refer to page 9.)

4 TAPE/MD MON / EXT. DECODER

Press this button to play a tape or an MD. The "TAPE/MD MON" indicator lights up on the display.

When you press the button next, the "TAPE/MD MON" indicator goes off and "EXT. DECDR" appears on the display and you can play the signal connected to the **EXTERNAL DECODER INPUT** terminals.

5 INPUT

Turn this selector to select the program source (VCR, VIDEO AUX, TV/DBS, DVD/LD, CD, TUNER, PHONO) to listen to or watch.

The name of the selected program source appears on the display.

6 VOLUME

This control is used to raise or lower the volume level.

7 PHONES jack

When you use headphones, connect the headphones to the **PHONES** jack. You can listen to the sound to be output from the main speakers through headphones.

When using headphones only, set both **SPEAKERS A** and **B** to the OFF position and switch off the digital sound field processor (so that no DSP program name appears on the display) by pressing **EFFECT**.

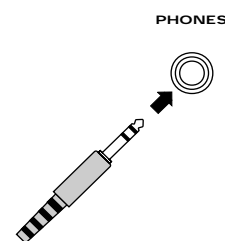



8 SPEAKERS

Set **A** or **B** (or both **A** and **B**) to the ON position for the main speaker system (connected to this unit) you will use. Set it (or them) for the main speaker system you will not use to the OFF position.

9 EFFECT

Switches on and off the output from the center and rear speakers so that the sound becomes normal 2-channel.

* Even if the output from the center and rear speakers is off, when the Dolby Digital is decoded, the signals at all channels are distributed to the main channels and output from the main speakers.

10 PROGRAM selector

Press these buttons to select the DSP program.
The name of the selected program appears on the display.

11 Tone controls

These controls are effective only for the sound from the main speakers.

BASS

Used to increase or decrease the low frequency response. The "0" position produces flat response.

TREBLE

Used to increase or decrease the high frequency response. The "0" position produces flat response.

12 BALANCE

This control is effective only for the sound from the main speakers.

Adjusts the balance of the output volume to the left and right speakers to compensate for sound imbalance caused by speaker location or listening room conditions.

13 SET MENU

Press this button to select functions in the SET MENU mode.

14 TIME/LEVEL

Press this button to select the setting of delay time or speaker output levels in the TIME/LEVEL mode.

15 +/-

These buttons are used to adjust settings of the SET MENU mode and the TIME/LEVEL mode. In the TIME/LEVEL mode, press **+** to increase delay time or speaker output levels. Press **-** to decrease delay time or speaker output levels.

16 INPUT MODE

Switches the DVD/LD and TV/DBS input signal mode (AUTO/ANALOG).

17 VIDEO AUX terminals

Connect an auxiliary video or audio input source unit such as a camcorder to these terminals. If the connected video unit has a S video output terminal, connect it to the **S VIDEO** terminal to obtain a high resolution picture. The source connected to these terminals can be selected by **INPUT**.



DISPLAY PANEL

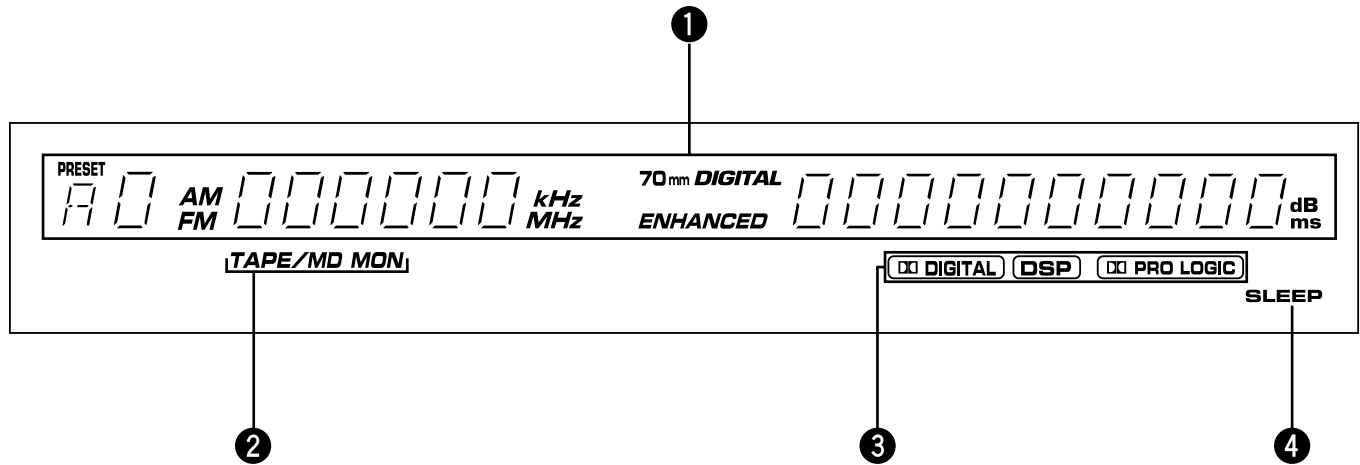

1 Multi-information display

Displays various information, for example name of selected DSP program and name of selected input source.

2 TAPE/MD MON indicator

Lights up when the tape deck (or MD recorder etc.) is selected as the input source by pressing **TAPE/MD MON / EXT. DECODER** on the front panel or **TAPE/MD** on the remote control transmitter.

3 DIGITAL, DSP and PRO LOGIC indicators

“**DIGITAL**” lights up when the built-in Dolby Digital decoder is on and the signals of selected source encoded with the Dolby Digital is not in 2-channel. “**DSP**” lights up when the built-in digital sound field processor is on, and “**PRO LOGIC**” lights up when the built-in Dolby Pro Logic Surround decoder is on. Depending on the selected DSP program, both “**DIGITAL**” and “**DSP**”, or both “**DSP**” and “**PRO LOGIC**” will light up.

4 SLEEP indicator

Lights up while the built-in SLEEP timer is functioning.



SPEAKER SETUP

SPEAKERS TO BE USED

This unit is designed to provide the best sound-field quality with a 5-speaker configuration, using main speakers, rear speakers and a center speaker.

The main speakers are used for the main source sound plus the effect sounds. They will probably be the speakers from your present stereo system. The rear speakers are used for the effect and surround sounds, and the center speaker is for the center sounds (dialog, vocals, etc.). If for some reason it is not practical to use a center speaker, you can do without it. Best results, however, are obtained with the full system.

The main speakers should be high performance models and have enough power handling capacity to accept the maximum output of your audio system.

Other speakers do not have to be equal to the main speakers. For precise sound localization, however, it is ideal to use high performance models that can reproduce sounds in the full range for the center speaker and the rear speakers.

Use of a subwoofer expands your sound field

It is also possible to further expand your system with the addition of a subwoofer and amplifier. The use of a subwoofer is effective not only for reinforcing bass frequencies from any or all channels, but also for reproducing the LFE (low frequency effect) sound with high fidelity when playing back a source with the Dolby Digital decoded. You may wish to choose the convenience of a YAMAHA Active Servo Processing Subwoofer System, which has its own built-in power amplifier.

SPEAKER CONFIGURATION

5-Speaker Configuration

This configuration is the most effective and recommended one. When playing back a source using the DSP program, **DOLBY PRO LOGIC/DOLBY DIGITAL, DOLBY PRO LOGIC ENHANCED/DOLBY DIGITAL ENHANCED, 70 mm MOVIE THEATER/DIGITAL MOVIE THEATER, MONO MOVIE** or **TV SPORTS**, or when playing back a source which contains center-channel signals (dialog, vocals, etc.) using any DSP program with the Dolby Digital decoded, conversations will be output from the center speaker and the ambience will be excellent.

Note: Set the CNTR (CENTER SPEAKER) mode to the "LARGE" or "SMALL" position. (For details, see page 19.)

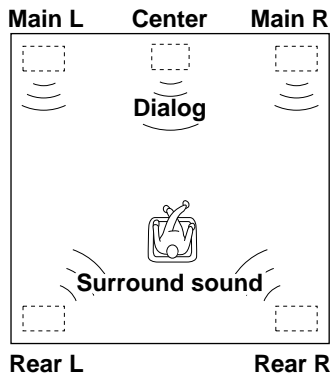

4-Speaker Configuration

The center speaker is not used in this configuration. When playing back a source using the DSP program, **DOLBY PRO LOGIC/DOLBY DIGITAL, DOLBY PRO LOGIC ENHANCED/DOLBY DIGITAL ENHANCED, 70 mm MOVIE THEATER/DIGITAL MOVIE THEATER, MONO MOVIE** or **TV SPORTS**, or when playing back a source which contains center-channel signals (dialog, vocals, etc.) using any DSP program with the Dolby Digital decoded, the center sound is output from the left and the right main speakers. However, the sound effect of other programs will be the same as that of the 5-speaker configuration.

Note: Be sure to set the CNTR (CENTER SPEAKER) mode to the "NONE" position. (For details, see page 19.)

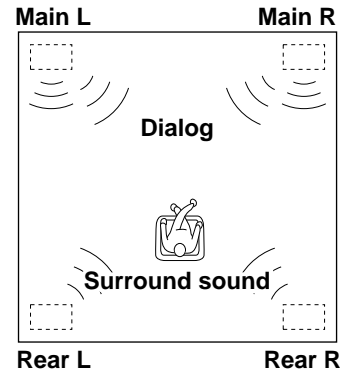



SPEAKER PLACEMENT

When you place the speakers, refer to the following diagram:

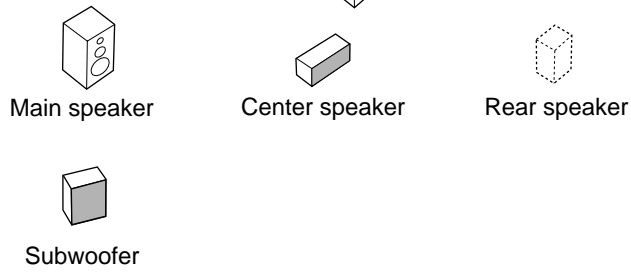
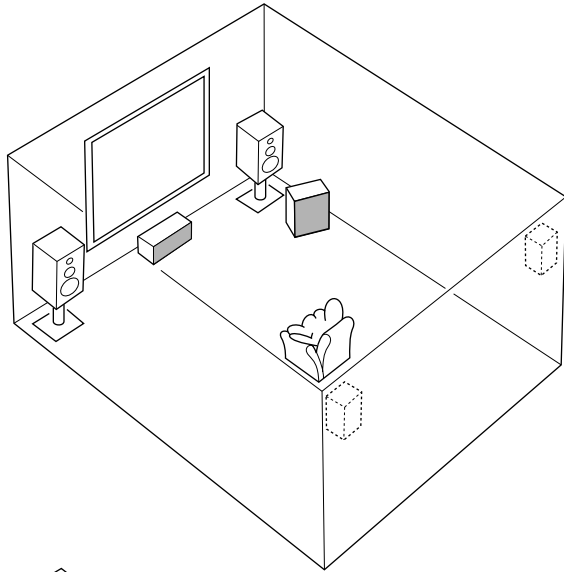

- Main:** The position of your present stereo speaker system.
- Rear:** Behind your listening position, facing slightly inward. Nearly 1.8 m (approx. 6 feet) up from the floor.
- Center:** Precisely between the main speakers. (To avoid interference with TV sets, use a magnetically shielded speaker.)
- Subwoofer:** The position of the subwoofer is not so critical because low bass tones are not highly directional.



CONNECTIONS

Never plug in this unit and other components until all connections are completed.

CONNECTIONS WITH OTHER COMPONENTS

When making connections between this unit and other components, be sure all connections are made correctly, that is to say L (left) to L, R (right) to R, “+” to “+” and “-” to “-”. Also, refer to the owner’s manual for each component to be connected to this unit.

* If you have YAMAHA components numbered as 1, 2, 3, 4, etc. on the rear panel, connections can be made easily by making sure to connect the output (or input) terminals of each component to the same-numbered terminals of this unit.

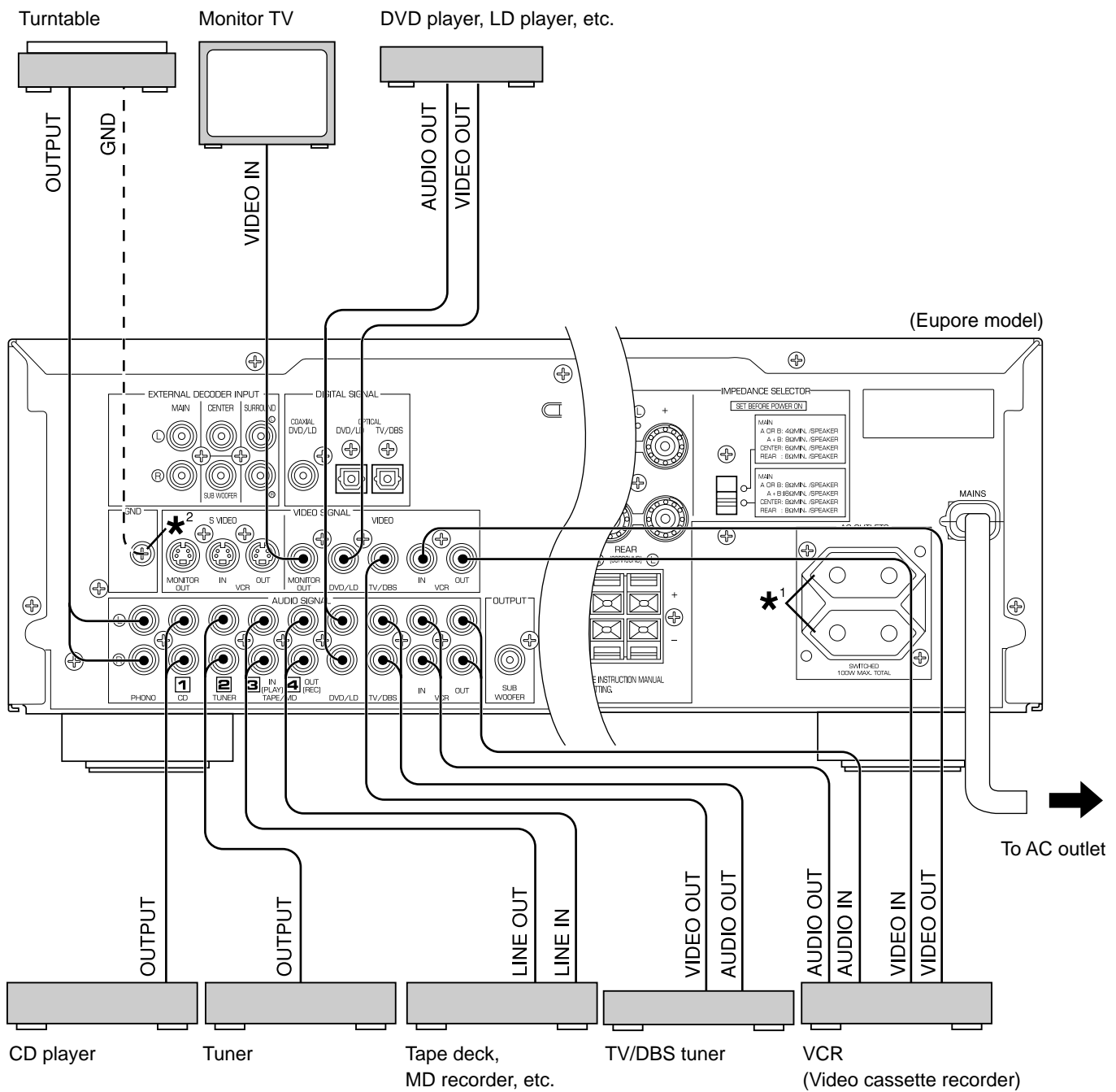

*¹, *² : See the next page.





*¹ SWITCHED AC OUTLET(S)

(China and General models) 3 SWITCHED OUTLETS
 (Europe models) 2 SWITCHED OUTLETS
 (U.K. model) 1 SWITCHED OUTLET

Use these to connect the power cords from your components to this unit.

The power to the **SWITCHED** outlets is controlled by this unit's **STANDBY/ON** or the provided remote control transmitter's **POWER** and **STANDBY**. These outlets will supply power to any component whenever this unit is turned on.

The maximum power (total power consumption of components) that can be connected to the **SWITCHED AC OUTLET(S)** is 100 watts.

*² GND terminal (For turntable use)

Connecting the ground wire of the turntable to the **GND** terminal will normally minimize hum, but in some cases better results may be obtained with the ground wire disconnected.

CONNECTING TO AN EXTERNAL DECODER

When using the DTS or other decoder with 6-channel discrete outputs, connect the **6CH DISCRETE OUTPUT** terminals of the decoder to the **EXTERNAL DECODER INPUT** terminals of this unit.

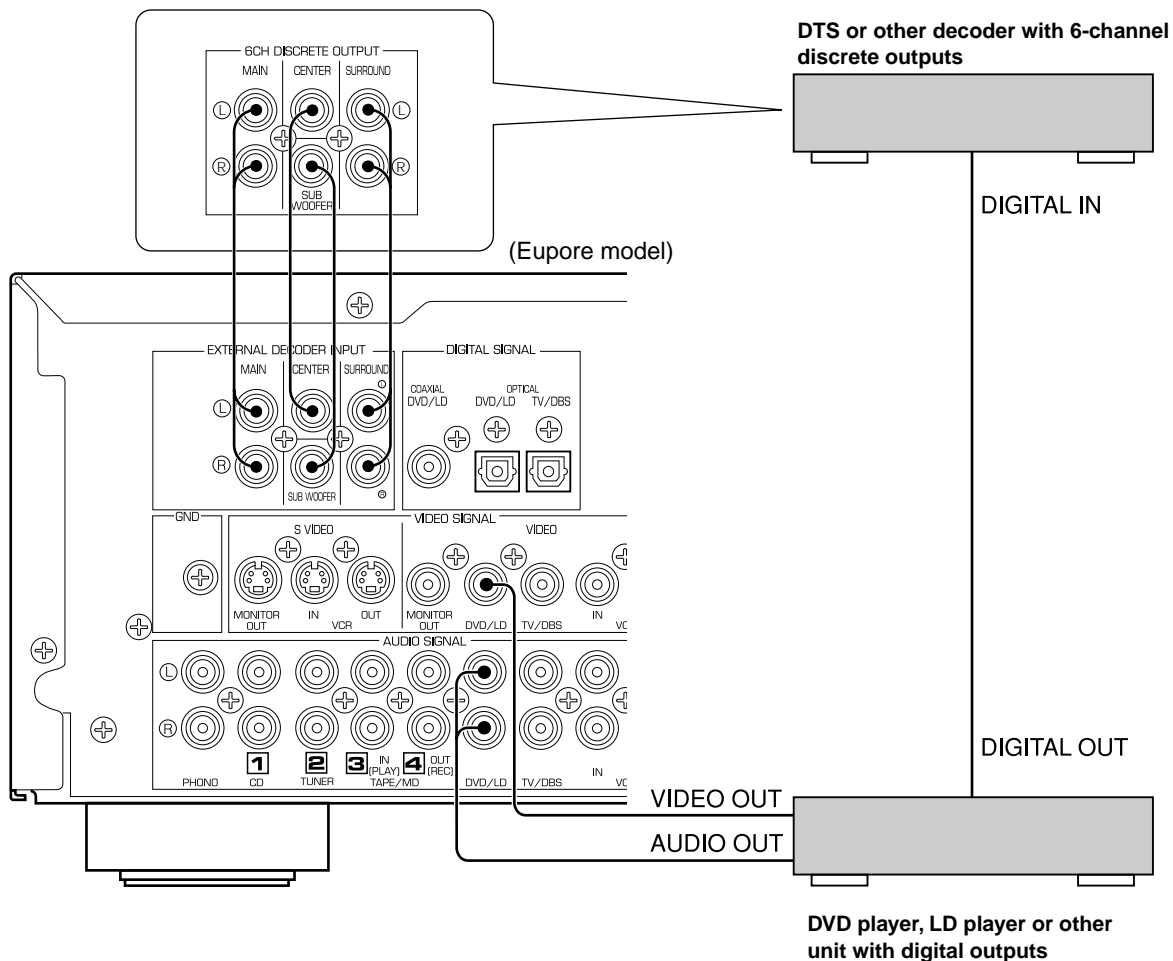



CONNECTING TO DIGITAL (COAXIAL AND/OR OPTICAL) TERMINALS

If your DVD (LD) player, TV/DBS tuner, etc. are equipped with coaxial or optical digital audio signal output terminals, they can be connected to this unit's **COAXIAL** and/or **OPTICAL** digital signal input terminals.

To make a connection between optical digital audio signal terminals, remove the cover from each terminal, and then connect them by using a commercially available optical fiber cable that conforms to EIAJ standards. Other cables might not function correctly.

Even if you connect an audio/video unit to the **COAXIAL** (or **OPTICAL**) terminal of this unit, you must keep the unit connected with the same named analog audio signal terminals of this unit, because digital signal cannot be recorded by a tape deck or VCR connected to this unit. You can switch the selection of input signals between "digital" and "analog" easily. (See page 26 for details.)

Notes

- When connecting an audio/video unit to both of the digital and analog terminals of this unit, make sure to connect to both terminals of the same name.
- Be sure to attach the covers when the **OPTICAL** terminals are not being used, in order to protect the terminals from dust.
- The input signal from the DVD/LD input terminals is selected in the following order of priority.
(input mode: AUTO position)
 - 1 **COAXIAL** terminal
 - 2 **OPTICAL** terminal
 - 3 ANALOG terminal
- All digital audio signal input terminals are applicable to the sampling frequency of 32 kHz, 44.1 kHz and 48 kHz.

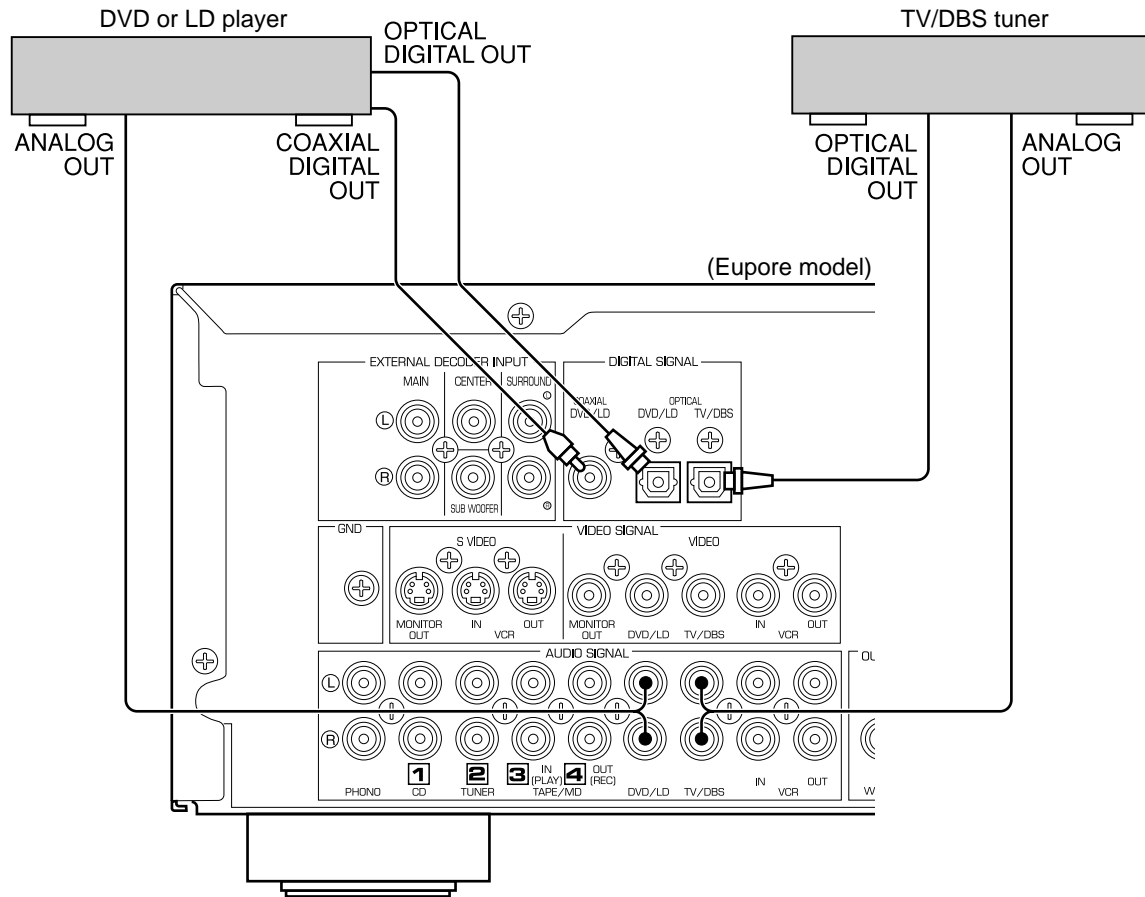

CONNECTING TO S VIDEO TERMINALS

If you have a VCR and a monitor equipped with “S” (high-resolution) video terminals, those terminals can be connected to this unit’s **S VIDEO** terminals. Connect the VCR’s “S” video input and output terminals to this unit’s **S VIDEO VCR OUT** and **IN** terminals respectively, and connect the monitor’s “S” video input terminal to this unit’s **S VIDEO MONITOR OUT** terminal. Otherwise, connect the VCR’s composite video terminals to this unit’s composite **VIDEO** terminals, and connect the monitor’s composite video input terminal to this unit’s composite **MONITOR OUT** terminal.

Note

If video signals are sent to both S VIDEO input and composite input terminals, the signals will be sent to their respective output terminals.

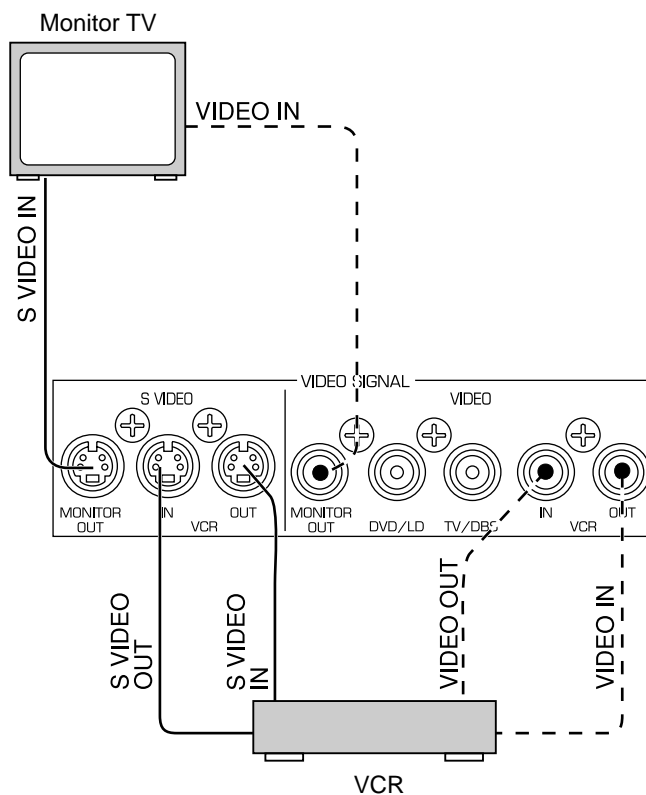

CONNECTING TO VIDEO AUX TERMINALS (ON THE FRONT PANEL)

These terminals are used to connect any video input source, such as a camcorder, to this unit.

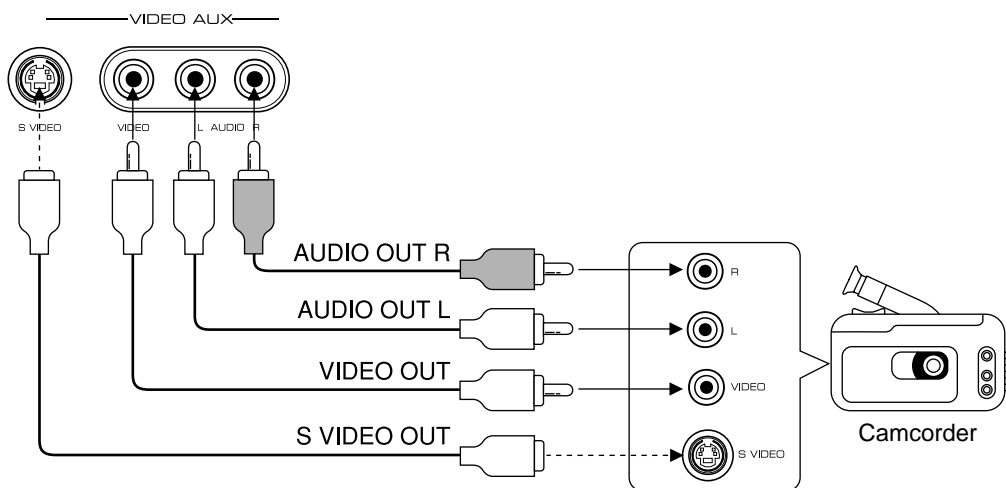

CONNECTING SPEAKERS

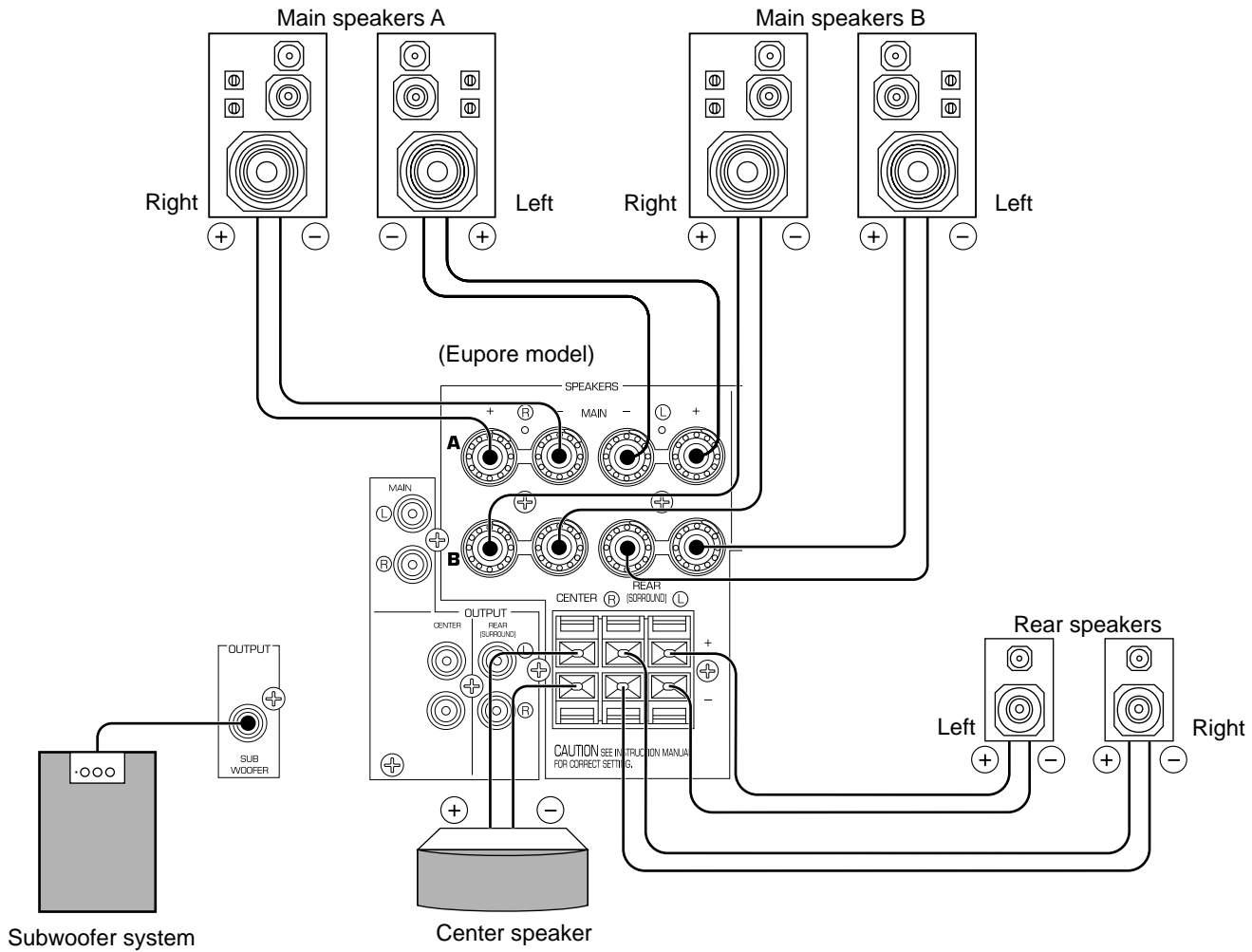

Note
Use speakers with the specified impedance shown on the rear panel of this unit.

Note on main speaker connections:
One or two speaker systems can be connected to this unit. If you use only one speaker system, connect it to either the **SPEAKERS A** or **B** terminals.

Note on a subwoofer connection:
You may wish to add a subwoofer to reinforce low frequencies or to output low bass sound from the subwoofer channel. If you have a subwoofer with built-in amplifier, including the YAMAHA Active Servo Processing Subwoofer System, connect the **SUBWOOFER OUTPUT** terminal of this unit to the input terminal of the subwoofer system. If you have an amplifier and a subwoofer, connect the **SUBWOOFER OUTPUT** terminal of this unit to the input terminal of the subwoofer amplifier, and then connect the speaker terminals of the subwoofer amplifier to the subwoofer.

Note on center speaker connection:
Center speaker can be connected to this unit. Place it on or under the TV.

How to connect

Connect the **SPEAKERS** terminals to your speakers with wire of the proper gauge, cut as short as possible. If the connections are faulty, no sound will be heard from the speakers. Make sure that the polarity of the speaker wires is correct, that is the + and - markings are observed. If these wires are reversed, the sound will be unnatural and lack bass.

Caution

Do not let the bare speaker wires touch each other and do not let them touch any metal part of this unit. This could damage this unit and/or speakers.

For connecting to the MAIN SPEAKERS terminals

Red: positive (+)
Black: negative (-)

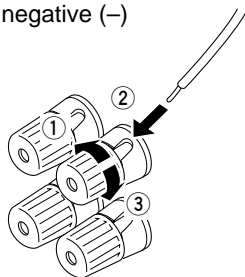

- ① Unscrew the knob.
- ② Insert the bare wire.
[Remove approx. 5 mm (1/4") insulation from the speaker wires.]
- ③ Tighten the knob and secure the wire.

For connecting to the REAR and CENTER SPEAKERS terminals

Red: positive (+)
Black: negative (-)

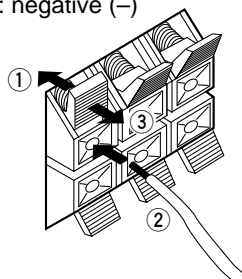

- ① Press the tab.
- ② Insert the bare wire.
[Remove approx. 5 mm (1/4") insulation from the speaker wires.]
- ③ Release the tab and secure the wire.

Banana plug connections are also possible (except for U.K. and Europe models). Simply insert the banana plug connector into the corresponding terminal.

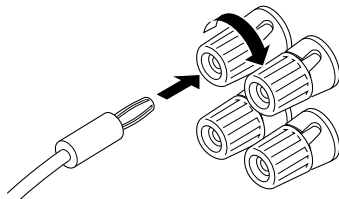

OUTPUT TERMINALS (FOR DRIVING SPEAKERS WITH EXTERNAL AMPLIFIERS)

(MAIN, CENTER and REAR OUTPUT terminals are provided for U.K. and Europe models only.)

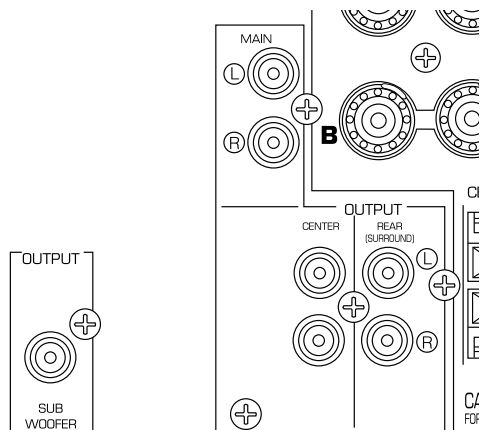

MAIN OUTPUT terminals

These terminals are for the main channel line output. There is no connection to these terminals when you use the built-in amplifier.

However, if you drive the main speakers with an external stereo power amplifier, connect the input terminals of the external amplifier (MAIN IN or AUX terminals of a power amplifier or an integrated amplifier) to these terminals.

* Output signals from the **MAIN OUTPUT** terminals are affected by the use of **BASS**, **TREBLE**, and **BALANCE**.



CENTER OUTPUT terminals

These terminals are for the center channel line output. There is no connection to these terminals when you use the built-in amplifier.

However, if you drive a center speaker with an external power amplifier, connect the input terminal of the external amplifier to this terminal.

If you are placing two center speakers on each side of the TV, use two amplifiers and connect each amplifier to one of the two **CENTER OUTPUT** terminals. Then connect the center speakers to the amplifiers.

REAR (SURROUND) OUTPUT terminals

These terminals are for the rear channel line output. There is no connection to these terminals when you use the built-in amplifier.

However, if you drive the rear speakers with an external stereo power amplifier, connect the input terminals of the external amplifier (MAIN IN or AUX terminals of a power amplifier or an integrated amplifier) to these terminals.

SUBWOOFER OUTPUT terminal

This terminal is for connecting to the input terminal of an amplifier for driving a subwoofer.

When the input signals to this unit are in normal 2-channel stereo, this terminal outputs only frequencies below 90 Hz from the main and center channels. When discrete signals are input to this unit and are selected as the input source, this terminal outputs signals from the subwoofer channel.

Note

Output levels of signals from all of these terminals are adjusted by the use of **VOLUME** on the front panel or **VOLUME** (^ v) on the remote control transmitter.

IMPEDANCE SELECTOR SWITCH

WARNING

Do not change the **IMPEDANCE SELECTOR** switch setting while the power of this unit is on, otherwise this unit may be damaged.

IF THIS UNIT FAILS TO TURN ON WHEN THE STANDBY/ON SWITCH IS PRESSED, the **IMPEDANCE SELECTOR** switch may not be fully set to either end. If so, set the switch to either end fully.

Select the position whose requirements your speaker system meets.

 (Upper position)

Main: If you use one pair of main speakers, the impedance of each speaker must be 4Ω or higher.
If you use two pairs of main speakers, the impedance of each speaker must be 8Ω or higher.

Center: The impedance of the speaker must be 6Ω or higher.

Rear: The impedance of each speaker must be 6Ω or higher.

 (Lower position)

Main: If you use one pair of main speakers, the impedance of each speaker must be 8Ω or higher.
If you use two pairs of main speakers, the impedance of each speaker must be 16Ω or higher.

Center: The impedance of the speaker must be 8Ω or higher.

Rear: The impedance of each speaker must be 8Ω or higher.

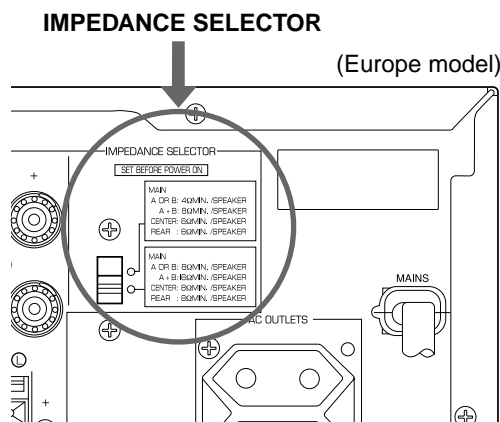

ADJUSTMENTS BEFORE USING THIS UNIT

SELECTING THE OUTPUT MODES

This unit provides you the following five functions to determine the method of distributing output signals to speakers suitable for your audio system. When speaker connections are all completed, select a proper position on each function to make the best use of your speaker system. (See "ADJUSTMENTS IN THE 'SET MENU' MODE" on page 35)

- | | | |
|---------------------------------|-------------------------------|-------------------------------|
| 1. CNTR (CENTER SPEAKER) | 2. REAR (REAR SPEAKER) | 3. MAIN (MAIN SPEAKER) |
| 4. BASS (LFE/BASS OUT) | 5. M.LVL (MAIN LEVEL) | |

DESCRIPTION OF EACH FUNCTION

1. CNTR (CENTER SPEAKER)

Choices: LARGE/SMALL/NONE

Preset position: LARGE

LARGE: Select this position when your center speaker is approximately the same size as the main speakers.

SMALL: Select this position when you use a center speaker that is smaller than the main speakers.
In this position, low bass signals (below 90 Hz) at the center channel are output from the main speakers (or the **SUBWOOFER OUTPUT** terminal if the **SMALL** position is selected on "3. MAIN" and the **SW** position is selected on "4. BASS").

NONE: Select this position when you do not have a center speaker. The center channel sound will be output from the left and right main speakers.

2. REAR (REAR SPEAKER)

Choices: LARGE/SMALL

Preset position: LARGE

LARGE: Select this position if your rear speakers have a high ability for bass reproduction, or a subwoofer is connected to the rear speaker in parallel.
In this position, full range signals are output from the rear speakers.

SMALL: Select this position if your rear speakers do not have a high ability for bass reproduction.
In this position, low bass signals (below 90 Hz) at the rear channels are output from the **SUBWOOFER OUTPUT** terminal (or the main speakers if the **MAIN** position is selected on "4. BASS").

3. MAIN (MAIN SPEAKER)

Choices: LARGE/SMALL

Preset position: LARGE

LARGE: Select this position if your main speakers have a high ability for bass reproduction.
In this position, full range signals present at the main channels are output from the main speakers.

SMALL: Select this position if your main speakers do not have a high ability for bass reproduction. However, if your system does not include a subwoofer, do not select this position.

In this position, low bass signals (below 90 Hz) at the main channels are output from the **SUBWOOFER OUTPUT** terminal if the **SW** or **BOTH** position is selected on "4. BASS".

4. BASS (LFE/BASS OUT)

Choices: SW/MAIN/BOTH

Preset position: SW

MAIN: Select this position if your system does not include a subwoofer.

In this position, full range signals present at the main channels, signals from the LFE channel and other low bass signals that are selected on "1. CNTR" to "3. MAIN" to be distributed from other channels are output from the main speakers.

SW/BOTH: Select either the **SW** or **BOTH** position if your system includes a subwoofer.

In either position, signals at LFE channel and other low bass signals that are selected on "1. CNTR" to "3. MAIN" to be distributed from other channels are output from the **SUBWOOFER OUTPUT** terminal. When the **LARGE** position is selected on "3. MAIN", in the **SW** position, no signal is distributed from the main channels to the **SUBWOOFER OUTPUT** terminal, however in the **BOTH** position, low bass signals from the main channels are output to both of the main speakers and the **SUBWOOFER OUTPUT** terminal.

5. M.LVL (MAIN LEVEL)

Choices: NORMAL (NRML)/-10 dB

Preset position: NORMAL (NRML)

NORMAL (NRML):

Normally select this position.

-10 dB: Select this position if the sound output from the main speakers is too loud and cannot be balanced with the sound output from the center and rear speakers. In this position, the sound output from the main speakers is attenuated.

ADJUSTING METHOD

Operations should be made while watching the information on this unit's display.

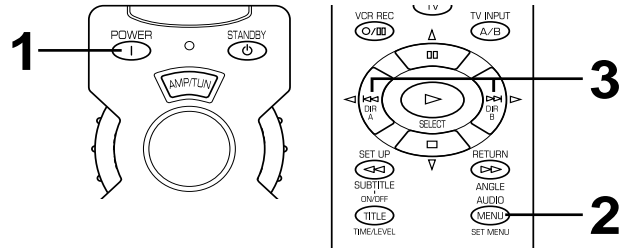
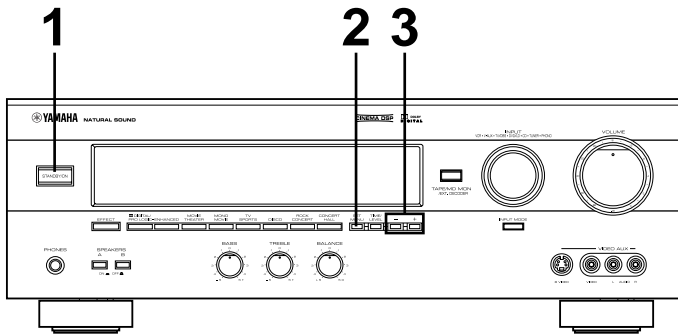

If you are using the remote control transmitter, set the **SELECTOR DIAL** to the AMP/TUN or DSP position on the remote control transmitter.

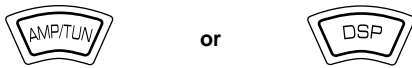

1 Turn the power on.

Front panel

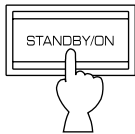

or

Remote control



2 Press **SET MENU** once or more to select the title "1. CNTR" (so that "CNTR" appears on the display).

Front panel



or

Remote control



* After pressing **SET MENU** once on the remote control transmitter, you can also select the title by pressing ∇ . (Pressing Δ goes back one selection.)



Appears.

3 Press + or – once or more to select the position you want.

Front panel

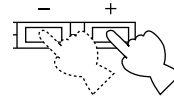

or

Remote control

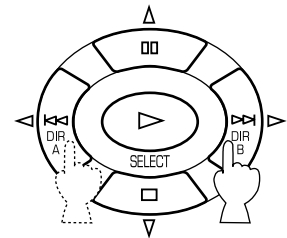

CNTR > SMALL

Changes.

4 Repeat steps 2 and 3 to change selections on "2. REAR", "3. MAIN", "4. BASS" and/or "5. M.LVL" in the same way.

SPEAKER BALANCE ADJUSTMENT

This procedure lets you adjust the sound output level balance between the main, center and rear speakers using the built-in test tone generator. When this adjustment is performed, the sound output level heard at the listening position will be the same from each speaker. This is important for the best performance of the digital sound field processor, the Dolby Digital decoder and the Dolby Pro Logic Surround decoder.

The adjustment of each speaker output level should be done at your listening position with the remote control transmitter. After completing the adjustment of the output level for each speaker, use VOLUME (^ v) on the remote control transmitter at your listening position to check if the adjustments are satisfactory.

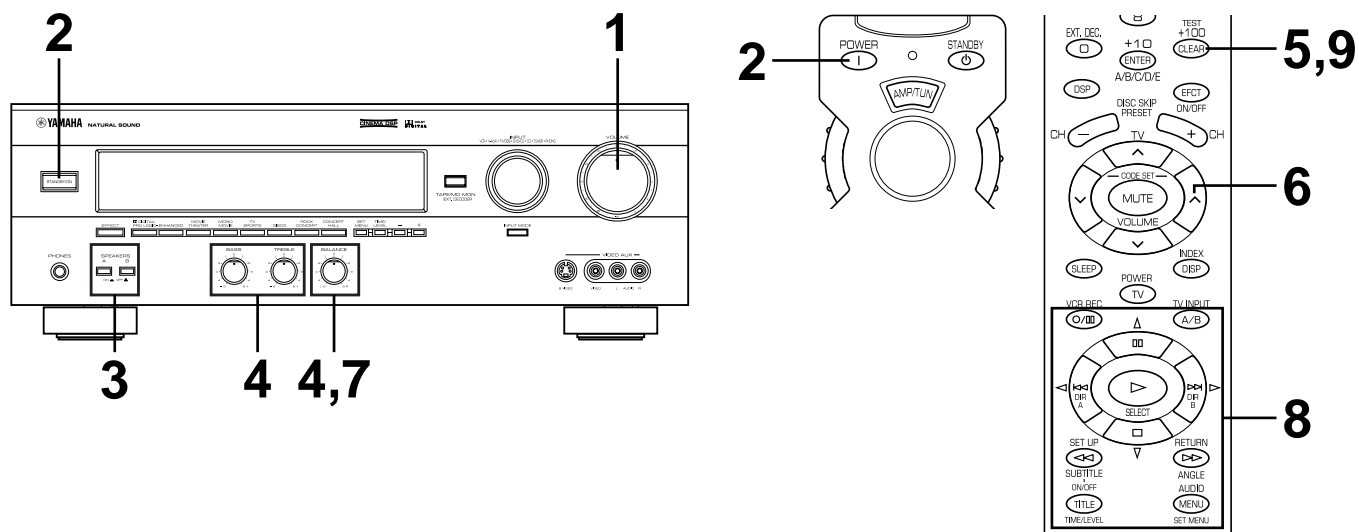

Set the **SELECTOR DIAL** to the AMP/TUN or DSP position on the remote control transmitter.

2 Turn the power on.

Front panel **Remote control**

1 Set **VOLUME** to the "∞" position.

Front panel

3 Select the main speakers to be used.

Front panel

* If you use two main speaker systems, press both **A** and **B**.



4 Set **BASS**, **TREBLE** and **BALANCE** to the "0" position.

Front panel

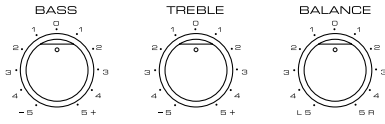

5 Press **TEST** (so that "TEST LEFT" appears on the display).

Remote control

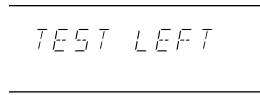

Appears.

6 Turn up the volume.

Remote control

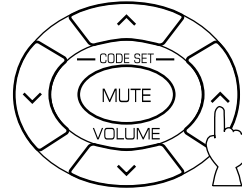

You will hear a test tone (like pink noise) from the left main speaker, then the center speaker, then the right main speaker, then the right rear speaker, and then the left rear speaker, for about two seconds each. The display changes as shown below.

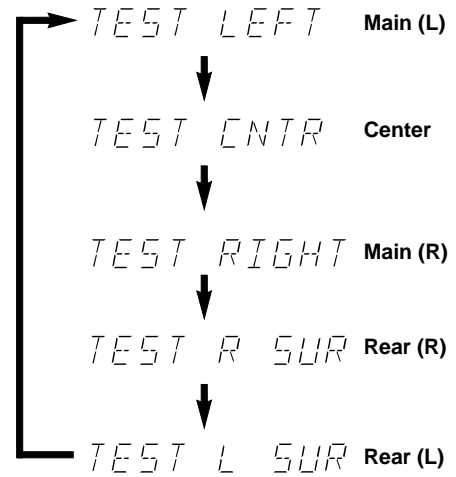

* If the function "1. CNTR" in the SET MENU mode is set to the NONE position, you will hear the center channel test tone from the left and right main speakers.

7 Adjust **BALANCE** so that the sound output level of the left main speaker and the right main speaker is the same.

Front panel

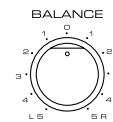



8 Adjust the sound output levels of the center speaker and the rear speakers so that they become almost as same as that of the main speakers.

Remote control



- a) Press Δ or ∇ once or more so that "CENTER", "R SUR." or "L SUR." appears on the display.
 - * Select "CENTER" to adjust the output level of the center speaker and select "R SUR." or "L SUR." to adjust the output level of the rear speakers.

Remote control

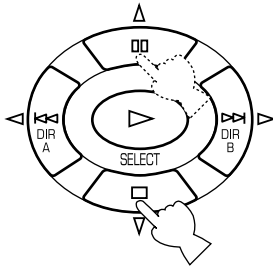

- b) Adjust the level.
 - * Pressing \triangleright raises and \triangleleft lowers the level.
 - * While adjusting, the test tone is fixed on the selected speaker.

Remote control

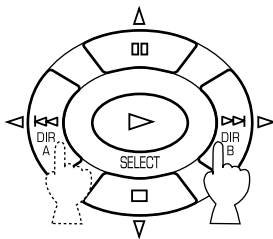

9 Press **TEST** once more to cancel the test tone.

Remote control



→ "TEST" disappears.

Notes

- Once you have completed these adjustments, you can adjust the overall sound level on your audio system by using **VOLUME** (or **VOLUME** ($\wedge \vee$)) on the remote control transmitter) only.
- If you use external power amplifiers, you may also use their volume controls to achieve the proper balance.
- If the function "1. CNTR" in the SET MENU mode is set to the NONE position, the sound output level of the center speaker cannot be adjusted in step 8. The center sound is automatically output from the left and right main speakers.
- If there is insufficient sound output from the center and rear speakers, you may decrease the main speaker output level by setting "5. M.LVL" to "-10 dB".

BASIC OPERATIONS

TO PLAY A SOURCE

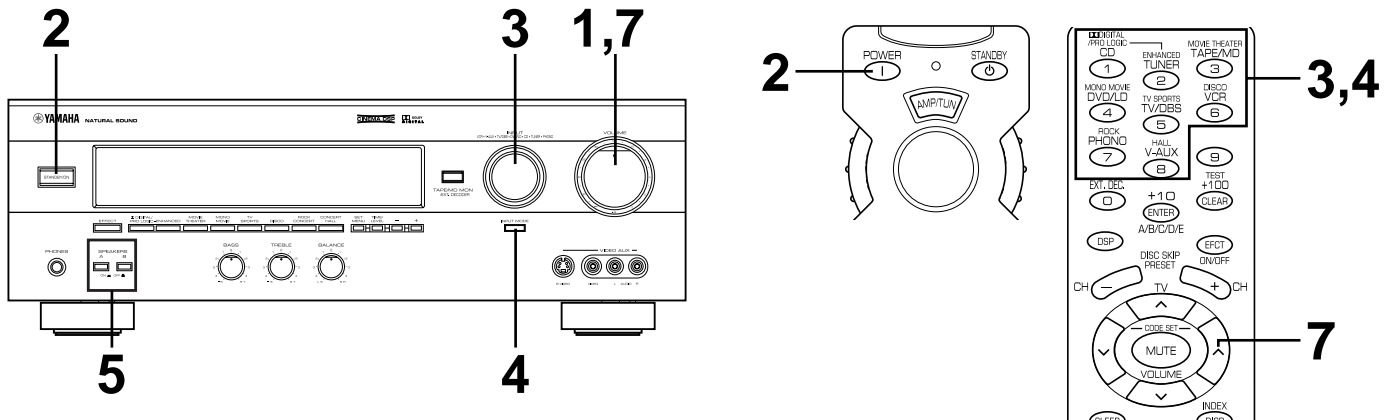

Notes

- Set the **SELECTOR DIAL** to the AMP/TUN position on the remote control transmitter.
- To operate the tuner, CD player, DVD/LD player, tape deck, MD recorder, or other components using this remote control transmitter, set the **SELECTOR DIAL** to the component to be used. (See "SETUP CODES" on page 42.)

- 1** Set **VOLUME** to the "∞" position.

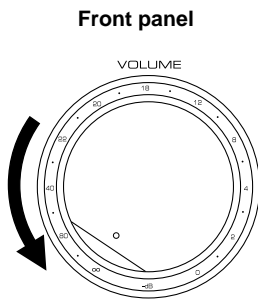

- 2** Turn the power on.

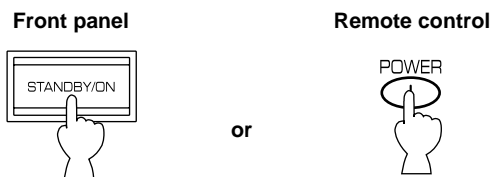

- 3** Select the desired input source by using **INPUT**.
(For video sources, turn the TV/monitor ON.)
See page 26 if you are using an external decoder or playing a tape or an MD.

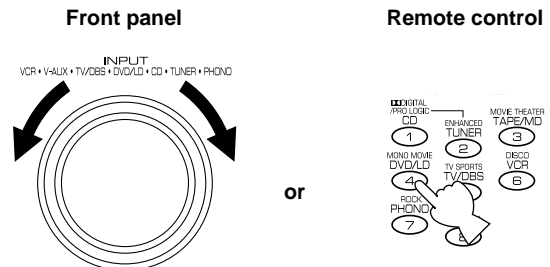

The name of the selected input source will appear on the display.



4 For the DVD/LD or TV/DBS source, the current input mode is also shown.
 * To change the input mode for the DVD/LD or TV/DBS source, press **INPUT MODE** (or the button that you have pressed to select the input source in step 3 on the remote control transmitter) once or more until the desired input mode (AUTO or ANALOG) is shown on the display. (See page 26 for details on switching the input mode.)

Front panel

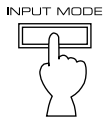

or

Remote control

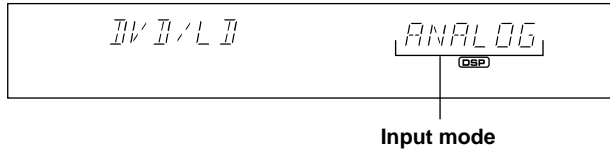
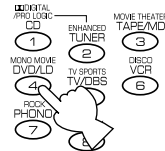

5 Select the main speakers to be used.

Front panel

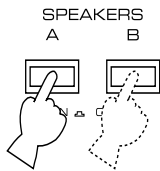

* If you use two main speaker systems, press both **A** and **B**.

6 Play the source.

7 Adjust the volume to the desired output level.

Front panel

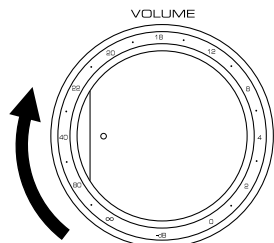

or

Remote control

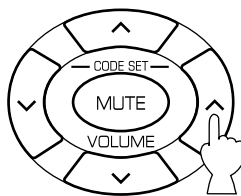

8 If desired, adjust **BASS**, **TREBLE**, **BALANCE**, etc. (see below) and use the digital sound field processor. (see page 29.)

Selecting the SPEAKER system

Because one or two speaker systems (as main speakers) can be connected to this unit, **SPEAKERS** allow you to select speaker system **A** or **B**, or both at once.

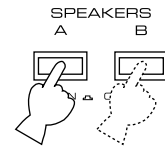

Adjusting the BALANCE control

Adjust the balance of the output volume from the left and right speakers to compensate for sound imbalances caused by speaker location or listening room conditions.

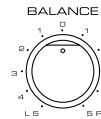

Note

This control is effective only for the sound from the main speakers.

Adjusting the BASS and TREBLE controls

BASS: Turn this clockwise to increase (or counter-clockwise to decrease) the low frequency response.

TREBLE: Turn this clockwise to increase (or counter-clockwise to decrease) the high frequency response.

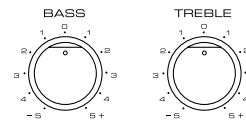

Note

These controls are effective only for the sound from the main speakers.



To play a tape or an MD

Press **TAPE/MD MON / EXT. DECODER** so that the "TAPE/MD MON" indicator lights up on the display, then play the tape or MD.

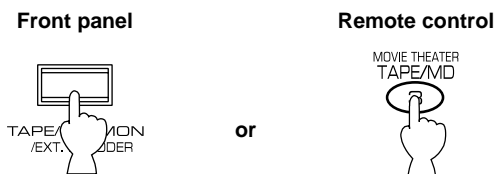

To stop playing the tape or MD, press **TAPE/MD MON / EXT. DECODER** twice so that the "TAPE/MD MON" indicator and "EXT. DECODER" disappear from the display and the play stops (or press **TAPE/MD** once on the remote control transmitter).

To use a decoder connected to the EXTERNAL DECODER INPUT terminals

Press **TAPE/MD MON / EXT. DECODER** once or more so that the "EXT. DECODER" appears on the display. Start the play by operating the DTS or other external decoder, DVD player or LD player.

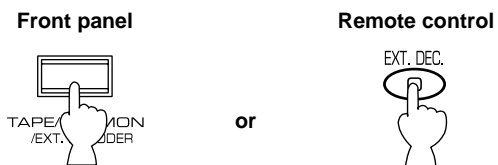

To stop playing, press **TAPE/MD MON / EXT. DECODER** once so that "EXT. DECODER" disappears from the display and the play stops (or press **EXT. DEC.** on the remote control transmitter).

When you finish using this unit

Press **STANDBY/ON** on the front panel again or **STANDBY** on the remote control transmitter to turn this unit into the standby mode.

Notes on using INPUT

- By using **INPUT**, you can to select the program sources connected to the input terminals on the rear panel.
- To play a video source connected to the **VIDEO AUX** terminals on the front panel, set **INPUT** to the VIDEO AUX position.
- The audio source selected by **INPUT** will not be played if the "TAPE/MD MON" indicator lights up or if "EXT. DECODER" is displayed.
- If you select **INPUT** for a video source without canceling the selection of **TAPE/MD MON / EXT. DECODER** on the front panel (or, **TAPE/MD** or **EXT. DEC.** on the remote control transmitter), the playback result will be the video image from the video source and the sound from the input source selected by **TAPE/MD MON / EXT. DECODER** on the front panel (or, **TAPE/MD** or **EXT. DEC.** on the remote control transmitter).

- Once you play a video source, its video image will not be interrupted even if **INPUT** for an audio source is selected.
- When you select an input source by using **INPUT**, the DSP program (or no DSP program) that was used when the same input source was selected the last time, will be automatically recalled.

Switching the input mode (for DVD/LD and TV/DBS)

This unit allows you to switch the input mode only for sources connected to the DVD/LD and TV/DBS input terminals (on the rear panel of this unit) that input two or three types of signals.

The following two input modes are provided.

AUTO: For the source connected to the DVD/LD input terminals:

This mode is automatically selected when you turn the power of this unit on. In this mode, input signal is automatically selected in the following order of priority.

1. Digital input signal from the **COAXIAL** terminal
2. Digital input signal from the **OPTICAL** terminal
3. Analog input signal

For the source connected to the TV/DBS input terminals:

This mode is selected when you turn the power of this unit on if the AUTO position is selected on "10. INPUT" in the SET MENU mode. (For details, see page 36.) In this mode, input signal is automatically selected in the following order of priority.

1. Digital input signal from the **OPTICAL** terminal
2. Analog input signal

ANALOG:

In this mode, only analog input signal is selected even if a digital signal is input at the same time. Select this mode when you want to use the analog input signal instead of the digital input signal.

Notes on input mode selection

- To playback a source with the Dolby Digital-decoded, set the input mode to AUTO.
- For the TV/DBS source only, the input mode selected on the function "10. INPUT" in the SET MENU mode is effective when you turn the power of this unit on.
- When you want to enjoy a source which has normal 2-channel signals with a Dolby Pro Logic Surround program, select the ANALOG mode.
- In the AUTO mode, there may be a case depending on some LD players or DVD players that when you make a search on a source encoded with the Dolby Digital during the play and then the play is restored, sound output is interrupted for a moment because the digital input signal is selected again.

TO RECORD A SOURCE TO TAPE OR MD

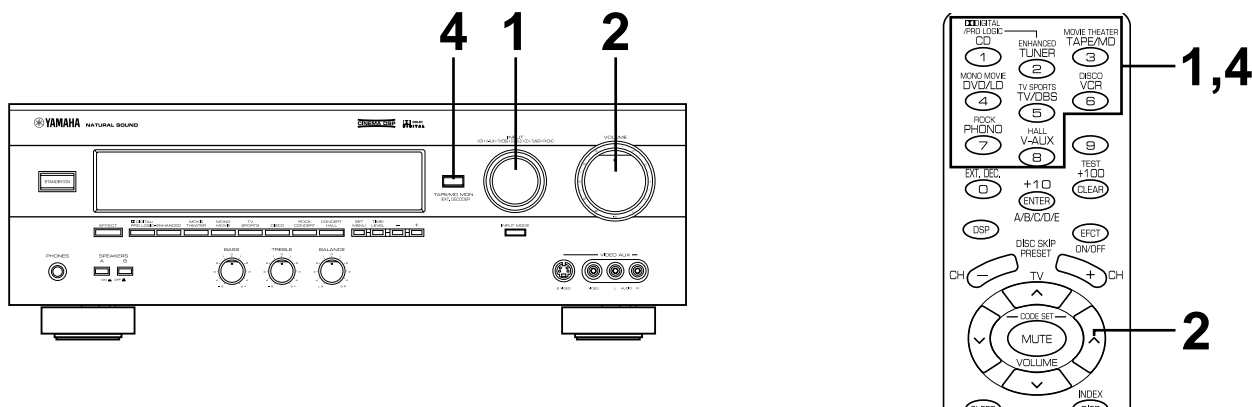

1 Select the source to be recorded.

Front panel

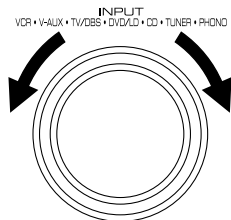

Remote control

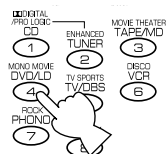

or

2 Play the source and then turn **VOLUME** up to confirm the input source.

Front panel

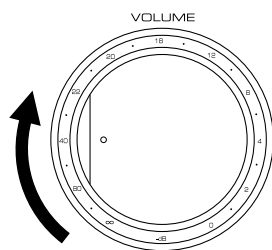

Remote control

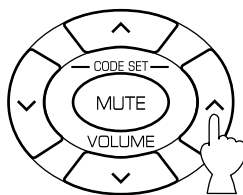

or

3 Begin recording on the tape deck, MD recorder or VCR connected to this unit.

4 When the tape deck or MD recorder is used for recording, you can monitor the sounds being recorded by pressing **TAPE/MD MON / EXT. DECODER** so that the "TAPE/MD MON" indicator lights up on the display.

Front panel

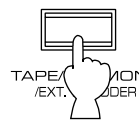

or

Remote control



Notes

- The settings of DSP and **VOLUME**, **BASS**, **TREBLE** and **BALANCE** have no effect on the material being recorded.
- Composite video and S video signals pass independently through this unit's video circuits. Therefore, when recording or dubbing video signals, if your video source unit is connected to provide only an S video (or only a composite video) signal, you can record only an S video (or only a composite video) signal on your VCR.
- A source that is connected to this unit through digital terminals only cannot be recorded by a tape deck or VCR connected to this unit.
- Please check the copyright laws in your country to record from records, compact discs, radio, etc. Recording of copyright material may infringe copyright laws.

If you watch a video software that uses scrambled or encoded signals to prevent it from being dubbed, there may be a case that the picture itself will be affected by those signals.



SETTING THE SLEEP TIMER

If you use the SLEEP timer of this unit, you can make this unit automatically switch to the standby mode. When you are going to sleep while enjoying a broadcast or other desired input source, this timer function is useful. The SLEEP timer can be controlled only with the remote control transmitter.

Notes

- To set the SLEEP timer for this unit, set the **SELECTOR DIAL** to a position other than the TV position. To set the SLEEP timer for your TV, set the **SELECTOR DIAL** to the TV position.
- The components on which the SLEEP timer is effective are the sources connected to the **SWITCHED AC OUTLET(S)** on the rear panel of this unit.

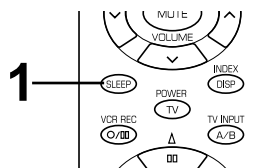

To set the SLEEP time

- 1 Press **SLEEP** once or more to select the desired SLEEP time.

Remote control



Indicates the SLEEP time.

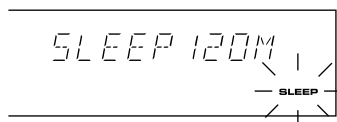

Flashes.

Whenever **SLEEP** is pressed, the SLEEP time will change as follows.

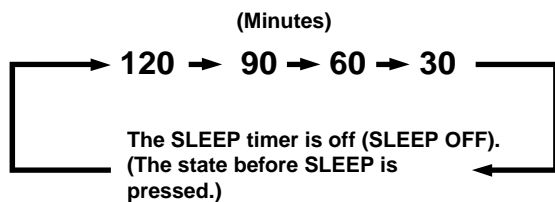

After a while, the "SLEEP" indicator lights up and the display returns to the indication before the SLEEP timer was set.

- 2 The unit will be switched to the standby mode automatically at the selected SLEEP time.

To cancel the selected SLEEP time

Remote control



Press **SLEEP** once or more so that "SLEEP OFF" appears on the display. (It will soon disappear and the "SLEEP" indicator will go off from the display.)

Note

The SLEEP timer setting can also be canceled by tuning this unit into the standby mode with **STANDBY/ON** on the front panel (or **STANDBY** on the remote control transmitter) or disconnecting the power plug of this unit from the AC outlet.



USING DIGITAL SOUND FIELD PROCESSOR (DSP)

This unit incorporates a sophisticated, multi-program digital sound field processor. The processor allows you to electronically expand and change the shape of the audio sound field from both audio and video sources, creating a theater-like experience in your listening room. You can create an excellent audio sound field by selecting a suitable sound field program (this will, of course, depend on what you are listening to), and adding any desired adjustments.

The following list gives you a brief description of the sound fields produced by each of the DSP programs. Keep in mind that most of these are precise digital recreations of actual acoustic environments. The data for these sound fields was recorded at actual locations using sophisticated sound field measurement equipment.

Note

The channel level balance between the left and right rear speakers may vary depending on the sound field you are listening to. This is due to the fact that most of these sound field are re-creation of actual acoustic environments.

BRIEF OVERVIEW OF DIGITAL SOUND FIELD PROGRAMS

No.	PROGRAM	FEATURE
1	<p>DOLBY PRO LOGIC (<input checked="" type="checkbox"/> PRO LOGIC) Functions when the input signal is analog or PCM audio, or encoded with the Dolby Digital in 2-channel. Speaker output: main, center, rear</p> <p>DOLBY DIGITAL (<input checked="" type="checkbox"/> DIGITAL) Functions when the input signal is encoded with the Dolby Digital (not in 2-channel). Speaker output: main, center, rear</p>	<p>Reproduces video discs, video tapes and similar sources which are Dolby Surround encoded and bear the "DOLBY SURROUND" logo.</p> <p>The built-in Dolby Pro Logic Surround decoder or Dolby Digital decoder precisely reproduces sounds and sound effects of a source encoded with Dolby Surround. The realization of a highly efficient decoding process improves crosstalk and channel separation and makes sound positioning smoother and more precise.</p>
2	<p>DOLBY PRO LOGIC ENHANCED (<input checked="" type="checkbox"/> DSP <input checked="" type="checkbox"/> PRO LOGIC) Functions when the input signal is analog or PCM audio, or encoded with the Dolby Digital in 2-channel. Speaker output: main, center, rear</p> <p>DOLBY DIGITAL ENHANCED (<input checked="" type="checkbox"/> DIGITAL <input checked="" type="checkbox"/> DSP) Functions when the input signal is encoded with the Dolby Digital (not in 2-channel). Speaker output: main, center, rear</p>	<p>Reproduces video discs, video tapes and similar sources which are Dolby Surround encoded and bear the "DOLBY SURROUND" logo.</p> <p>This program ideally simulates the multi-surround speaker systems of the 35 mm film theater. The Dolby Surround decoding and the digital sound field processing is precisely performed without altering the original sound orientation. The surround effects produced by this sound field folds around the viewer naturally from the rear to the left and right and toward the screen.</p> <p>Note: If the main channel sound is considerably altered by overadjustment of BASS or TREBLE, the relationship with the rear channels may produce an unnatural effect.</p>
3	<p>70 mm MOVIE THEATER (<input checked="" type="checkbox"/> DSP <input checked="" type="checkbox"/> PRO LOGIC) Functions when the input signal is analog or PCM audio, or encoded with the Dolby Digital in 2-channel. Speaker output: main, center, rear</p> <p>DIGITAL MOVIE THEATER (<input checked="" type="checkbox"/> DIGITAL <input checked="" type="checkbox"/> DSP) Functions when the input signal is encoded with the Dolby Digital (not in 2-channel). Speaker output: main, center, rear</p>	<p>Ideal for reproducing video discs, video tapes and similar sources which are Dolby Surround encoded and bear the "DOLBY SURROUND" logo.</p> <p>This program is ideal for precisely reproducing the sound design of the newest 70 mm/Dolby Digital multi-track films. The sound field is made to be similar to that of the newest movie theaters, so the reverberations of the sound field itself are restrained as much as possible. The three dimensional feeling of the sound field is emphasized, and dialog is precisely oriented on the screen. You can enjoy watching Sci-Fi, adventure movies, etc. with considerable presence.</p>



No.	PROGRAM	FEATURE
4	<p>MONO MOVIE (DSP) Functions when the input signal is analog or PCM audio, or encoded with the Dolby Digital in 2-channel. Speaker output: main, center, rear</p> <p>(DIGITAL DSP) Functions when the input signal is encoded with the Dolby Digital (not in 2-channel). Speaker output: main, center, rear</p>	<p>This program is designed specifically to enhance mono source programs. Compared to a strictly mono setting, the sound image created in this mode is wider and slightly forward of the speaker pair, lending an immediacy to the overall sound. It is particularly effective when used with old mono movies, news broadcasting and dialog.</p>
5	<p>TV SPORTS (DSP) Functions when the input signal is analog or PCM audio, or encoded with the Dolby Digital in 2-channel. Speaker output: main, center, rear</p> <p>(DIGITAL DSP) Functions when the input signal is encoded with the Dolby Digital (not in 2-channel). Speaker output: main, center, rear</p>	<p>This program is furnished with a tight sound field in which the sound will not spread excessively on the front side, but the rear surround side produces a dynamic sound expansion. This program is the most suitable for sports programs.</p>
6	<p>DISCO (DSP) Functions when the input signal is analog or PCM audio, or encoded with the Dolby Digital in 2-channel. Speaker output: main, rear</p> <p>(DIGITAL DSP) Functions when the input signal is encoded with the Dolby Digital (not in 2-channel). Speaker output: main, center, rear</p>	<p>This program recreates the acoustic environment of a lively disco in the heart of a very lively city. The sound is dense and highly concentrated. It is also characterized by a high-energy, "immediate" sound.</p>
7	<p>ROCK CONCERT (DSP) Functions when the input signal is analog or PCM audio, or encoded with the Dolby Digital in 2-channel. Speaker output: main, rear</p> <p>(DIGITAL DSP) Functions when the input signal is encoded with the Dolby Digital (not in 2-channel). Speaker output: main, center, rear</p>	<p>This program is ideally suited for rock music. You will experience a very dynamic and lively sound field.</p>
8	<p>CONCERT HALL (DSP) Functions when the input signal is analog or PCM audio, or encoded with the Dolby Digital in 2-channel. Speaker output: main, rear</p> <p>(DIGITAL DSP) Functions when the input signal is encoded with the Dolby Digital (not in 2-channel). Speaker output: main, center, rear</p>	<p>In this program, the center will appear to be deep behind the main speakers, creating an expansive, large hall ambience. Orchestra and opera music are suited to this sound field.</p>

Note: When the NONE position is selected on "1. CNTR" in the SET MENU mode, no sound is output from the center speaker(s).



PLAYING A SOURCE WITH THE DIGITAL SOUND FIELD PROCESSOR (DSP) EFFECT

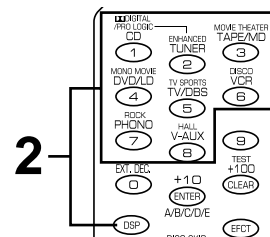
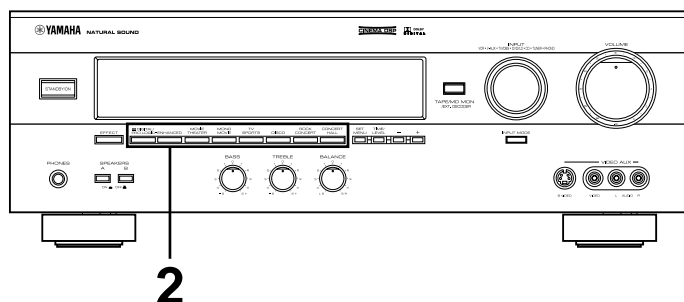

1 Follow steps 1 to 7 shown in “BASIC OPERATIONS” on pages 24 to 25.

2 Select the desired DSP program that is suitable for the source.

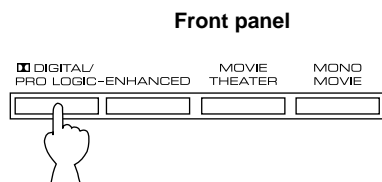

or

Remote control

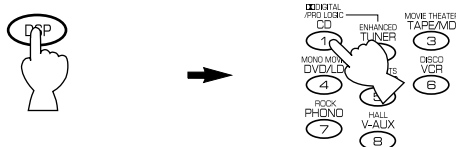

Press **DSP**. While the indicator lights up for about three seconds, select a DSP program using the numeric buttons (1 to 8).

* If the **SELECTOR DIAL** is set to the DSP position, you can also select a DSP program using the numeric buttons (1 to 8).

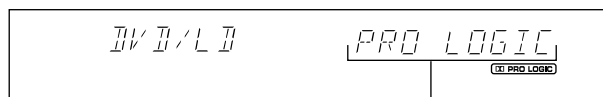

The name of selected program appears on the display.

3 If desired, adjust the delay time and the output level of each speaker. (For details, see pages 33 and 34.)

Notes

- You can select the program for each of the input sources. Once you select a program, it is linked with the input source selected at that time. So, when you select the input source next time, the same program is automatically called.
- If you prefer to cancel the DSP, press **EFFECT** or **EFCT ON/OFF**. The sound will be the normal 2-channel stereo without surround sound effect.
- When a monaural sound source is played with **DOLBY PRO LOGIC** or **DOLBY PRO LOGIC ENHANCED**, no sound is heard from the main speakers and the rear speakers. Sound is heard only from the center speaker. However, if the NONE position is selected on “1. CNTR” in the SET MENU mode, the main speakers output the sound of the center channel.
- If the main-source sound is considerably altered by overadjustment of **BASS** or **TREBLE** when this unit's Dolby Pro Logic Surround decoder or Dolby Digital decoder is used, the relationship between the center and rear channels may produce an unnatural effect.



This unit incorporates a Dolby Digital decoder and a Dolby Pro Logic Surround decoder for multi-channel sound reproduction of sources encoded with Dolby Surround. The operation of these decoders can be controlled by selecting a corresponding DSP program including the combined operation of YAMAHA DSP and Dolby Digital or Dolby Pro Logic Surround.

To enjoy a video source with the Dolby Pro Logic Surround or Dolby Digital decoded

When you select the program **DOLBY PRO LOGIC/DOLBY DIGITAL**, **DOLBY PRO LOGIC ENHANCED/DOLBY DIGITAL ENHANCED** or **70 mm MOVIE THEATER/DIGITAL MOVIE THEATER**, and the input signal of the source is 2-channel stereo, Dolby Pro Logic Surround is decoded. When some program is selected and the input signal of the source is encoded with Dolby Digital, Dolby Digital is automatically decoded.

* The following indicators on the display show you what sound processing is being made.

Lights up when the Dolby Digital is being decoded and the input signals of selected source encoded with Dolby Digital is not in 2-channel.

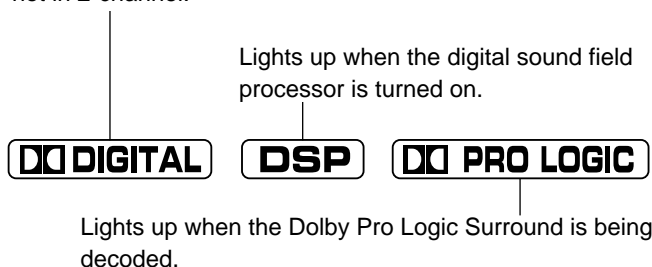

* In addition, for the program **DOLBY PRO LOGIC/DOLBY DIGITAL**, **DOLBY PRO LOGIC ENHANCED/DOLBY DIGITAL ENHANCED** or **70 mm MOVIE THEATER/DIGITAL MOVIE THEATER**, the name of the program on the display will change according to the type of decoding. (For details, see page 29.)

Note

If the input signals of the source are encoded with Dolby Digital in 2-channel only, the sound processing for them is similar to that for analog or PCM audio signals.

To cancel the effect sound

EFFECT on the front panel and **EFCT ON/OFF** on the remote control transmitter make it simple to compare the normal stereo sound with the fully processed effect sound.

To cancel the effect sound and monitor only the main sound, press **EFFECT** or **EFCT ON/OFF**. Press **EFFECT** or **EFCT ON/OFF** once more to turn effect sound on.

Front panel



or

Remote control



Notes

- If the effect sound is canceled when signals encoded with Dolby Digital are input to this unit, signals of all channels are mixed and are output from the main speakers.
- If **EFFECT** or **EFCT ON/OFF** is pressed to turn effect sounds off when the Dolby Digital is decoded, it may happen that the sound is output faintly or not output normally depending on the source. In that case, press **EFFECT** or **EFCT ON/OFF** to turn effect sounds on, or use input signals not encoded with Dolby Digital.



ADJUSTING DELAY TIME AND SPEAKER OUTPUT LEVELS

When using the digital sound field processor including the Dolby Pro Logic Surround decoder or the Dolby Digital decoder, you can adjust the delay time between the main sound and effect sound, and each speaker's output level as you prefer.

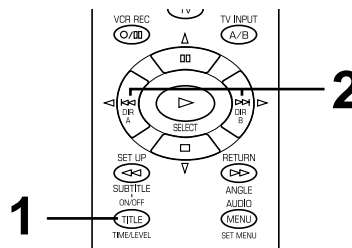
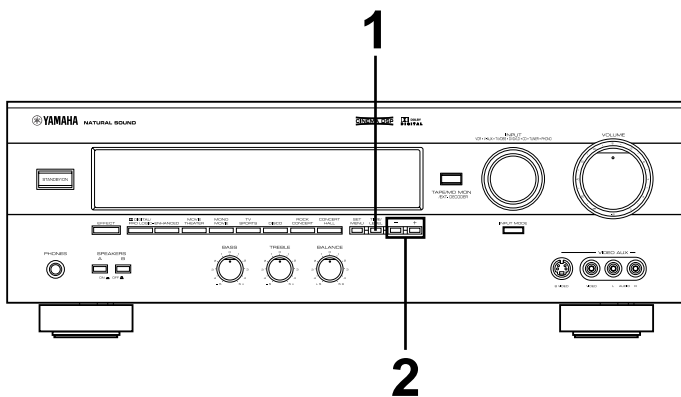

Adjusting method

If you are using the remote control transmitter, set the **SELECTOR DIAL** to the AMP/TUN or DSP position on the remote control transmitter.



or



- 1 Press **TIME/LEVEL** once or more until the name of item which you want to adjust appears on the display.

Front panel



or

Remote control



* After pressing **TIME/LEVEL** once on the remote control transmitter, you can also select the name of item by pressing ∇ .

When pressed, the selection changes as follows:

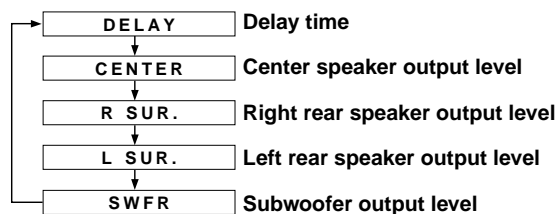

* Pressing Δ on the remote control transmitter changes the selection in the reverse order.

* Depending on the mode of this unit, you cannot select all items.

- 2 Press **+** or **-** to adjust the settings for delay time or speaker output levels.

Front panel

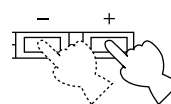

or

Remote control

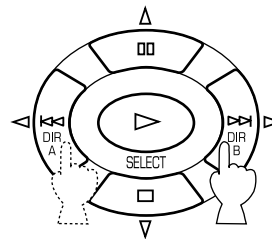

- 3 Repeat steps 1 to 3 to adjust settings on any other item.



Adjusting delay time

You can adjust the time difference between the beginning of the sound from the main speakers and the beginning of the effect sound from the rear speakers.

The larger the value, the later the effect sound is generated.

This adjustment can be made to all programs individually.

Notes

- Adding too much delay will cause an unnatural effect with some sources.
- When + or – is pressed, the sound is momentarily interrupted.

Program	Control range (ms)	Preset value
1. DOLBY PRO LOGIC	15 to 30	20
DOLBY DIGITAL	0 to 15	5
2. DOLBY PRO LOGIC ENHANCED	15 to 30	20
DOLBY DIGITAL ENHANCED	0 to 15	5
3. 70 mm MOVIE THEATER	15 to 30	20
DIGITAL MOVIE THEATER	1 to 99	16
4. MONO MOVIE	1 to 99	49
5. TV SPORTS	1 to 99	9
6. DISCO	1 to 99	40
7. ROCK CONCERT	1 to 99	16
8. CONCERT HALL	1 to 99	44

Adjusting output level of the center, right rear and left rear speakers, and subwoofer

If desired, you can adjust the sound output level of each speaker even if the output level is already set in "SPEAKER BALANCE ADJUSTMENT" on pages 21 to 23.

Notes

- Output level of the center speaker cannot be adjusted when the program **DISCO**, **ROCK CONCERT** or **CONCERT HALL** is selected, and the input signal is analog, PCM audio, or encoded with Dolby Digital in 2-channel.

- If the function "1. CNTR" in the SET MENU mode is set to the NONE position, the sound output level of the center speaker cannot be adjusted. This is because, in this mode, the center sound is automatically output from the left and right main speakers.
- Once the output level is adjusted, the level will be the same for all digital sound field programs.

Speakers	Control range (dB)	Preset value
CENTER	MIN, -20 to +10	0
RIGHT SURROUND (Rear)	MIN, -20 to +10	0
LEFT SURROUND (Rear)	MIN, -20 to +10	0
SUBWOOFER	MIN, -20 to 0	0

Note

The values of the delay time, center/rear/subwoofer output level you set the last time will remain memorized even when this unit is in the standby mode. However, if the power cord is kept disconnected for more than one week, these values will automatically change back to the original factory settings.





ADJUSTMENTS IN THE "SET MENU" MODE

The following ten types of functions maximize the performance of your system and expand your enjoyment for audio listening and video watching.

- 1. CNTR (CENTER SPEAKER)
- 2. REAR (REAR SPEAKER)
- 3. MAIN (MAIN SPEAKER)
- 4. BASS (LFE/BASS OUT)
- 5. M.LVL (MAIN LEVEL)
- 6. LFE (LFE LEVEL)
- 7. D.RNG (DYNAMIC RANGE)
- 8. C.DELAY (CENTER DELAY)
- 9. GUARD (MEMORY GUARD)
- 10. INPUT (INPUT MODE)

For details on "1. CNTR", "2. REAR", "3. MAIN", "4. BASS" and "5. M.LVL", see page 19. (Once you have selected the appropriate modes, you do not have to change settings unless any alteration is made in your speaker system.)

6. LFE [Adjusting the output level of the LFE (low frequency effect) channel]

Control range: -20 dB to 0 dB (in 1 dB step)
Preset value: 0 dB

* This adjustment is effective only when the Dolby Digital is decoded and the signals of selected source encoded with the Dolby Digital contain LFE signals.

Adjusts the output level of the LFE (low frequency effect) channel. If the LFE signals are mixed with signals of other channels to output them from the same speakers, the ratio of LFE signal level to the level of other signals are adjusted. (See page 5 for details about the LFE channel.)

7. D.RNG (Adjusting dynamic range)

Choices: MAX/STD/MIN
Preset position: MAX

* This adjustment is effective only when the Dolby Digital is decoded.

MAX: "Dynamic range" is the difference between the maximum level and the minimum level of sounds. Sounds on a movie originally designed for movie theaters feature very wide dynamic range. Dolby Digital technology can bring the original sound track into a home audio format with this wide dynamic range unchanged. In this position, a source encoded with the Dolby Digital is reproduced in the original sound track's wide dynamic range providing you with powerful sounds just like in a movie theater. Selecting this position will be even better if you can listen to a source in a high output level in a room specially soundproofed for audio/video enjoyment.

STD (Standard): Powerful sounds of extremely wide dynamic range are not always suitable for home use. Depending upon the condition of your listening environment, it may not be possible to increase the sound output level as high as a movie theater. However, in a level suitable for listening to in your room, the low level parts of source sound often cannot be heard so well because they will be lost among noises in your environment. Dolby Digital technology also made it possible to reduce an original sound track's dynamic range for a home audio format by "compressing" the data of sound.

MIN: In this position, dynamic range is more reduced than in the STD position. Selecting this position will be effective when you must listen to a source at lower level.



8. C.DELAY [Adjusting the delay of center sounds (dialog etc.)]

Control range: 0 ms to 5 ms (in 1 ms step)
Preset value: 0 ms

* This adjustment is effective only when the Dolby Digital is decoded and the signals of selected source encoded with the Dolby Digital contain center-channel signals.

Adjusts the delay between the main sounds (at the main channels) and dialog etc. (at the center channel).
 The larger the value, the later the dialog etc. is generated.

This is for making sounds from the left main, center and right main speakers reach your listening position at the same time. This is achieved by delaying the sound from the center speaker if the distance from the center speaker to your listening position is shorter than the distance from the left or right main speaker to your listening position.

9. GUARD

Choices: ON/OFF
Preset position: OFF

If you wish to prevent accidental alteration to SET MENU and other adjustments on this unit, select ON. The following functions on this unit can be locked by this operation.

- Functions in the SET MENU mode
- Functions in the TIME/LEVEL mode
- Functions when using TEST

10. INPUT (Selecting the initial input mode of the sources connected to the TV/DBS input terminals)

For the sources connected to the TV/DBS input terminals of this unit only, you can designate the input mode that is automatically selected when the power of this unit is switched on.

- AUTO:** In this position, the AUTO input mode is always selected when the power of this unit is switched on.
- LAST:** In this position, the input mode you selected last time is memorized and will not be changed even if the power of this unit is switched on.

* See page 26 for details on switching the input mode.

Adjusting method

Operations should be made while watching the information on this unit's display.

If you are using the remote control transmitter, set the **SELECTOR DIAL** to the AMP/TUN or DSP position on the remote control transmitter.

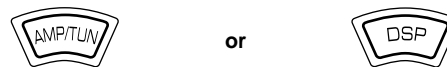

Press **SET MENU** once or more so that the title of function which you want to change appears on the display.



* After pressing **SET MENU** once on the remote control transmitter, you can also select the title by pressing ▽. (Pressing ▲ goes back one selection.)

Press **+** or **-** to select any desired position or edit parameters on the function.

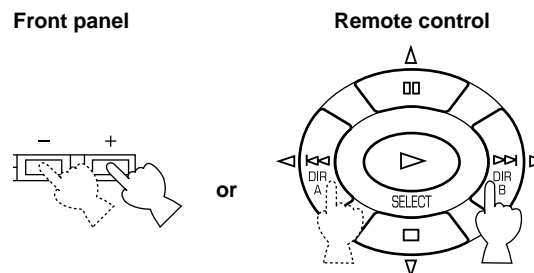

Repeat these steps to change and adjust settings on any other function.

REMOTE CONTROL TRANSMITTER

You can use this remote control transmitter to control not only this unit but also other components connected to it. This is factory set to control this unit and most YAMAHA audio components. To control other brands of components, you must preset the remote control transmitter with the manufacturer's codes listed on pages 311 to 322.

Components which can be controlled

There are nine positions that you can select to control connected components with this remote control transmitter. When turning the **SELECTOR DIAL**, the position changes as follows:

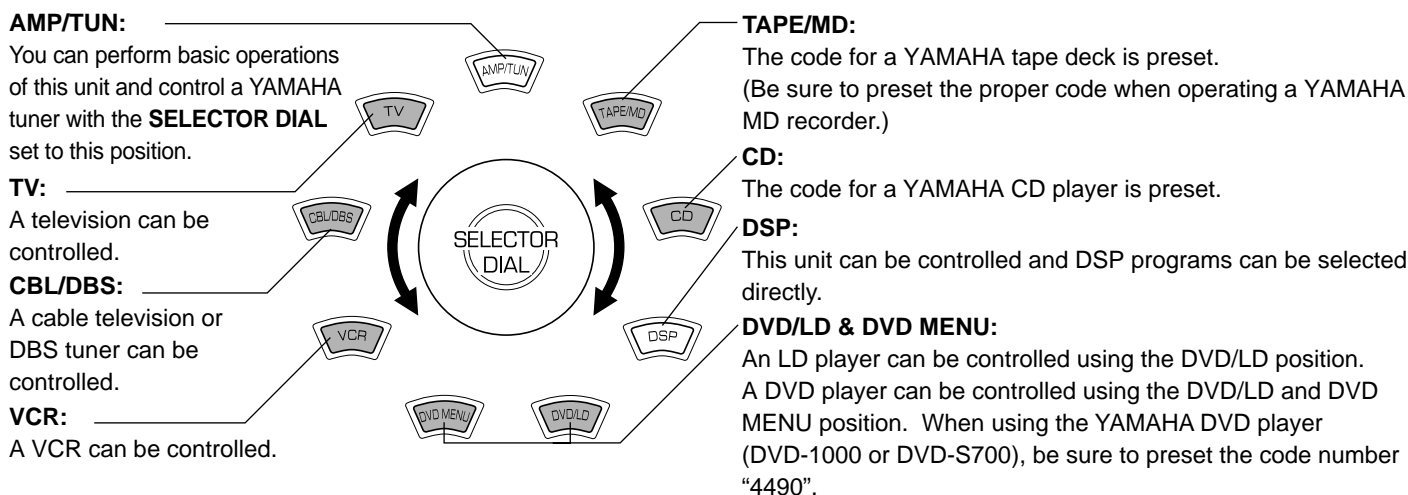

Notes

- The shaded positions in the diagram above indicate that you can preset the code for the manufacturer of your component. Note that you can preset only one code for one position. For details, see "SETUP CODES" on page 42.
- The DVD/LD and DVD MENU positions
 - Be sure that the **SELECTOR DIAL** is set to the DVD/LD position when presetting the code for a DVD or an LD player. The code that you preset to the DVD/LD position is also preset to the DVD MENU position simultaneously. You cannot preset the code for a DVD player when the **SELECTOR DIAL** is set to the DVD MENU position.
 - DVD MENU operations cannot be performed for some DVD players.
- When using a second (and third) VCR (For details, see "To use a second (and third) VCR" on page 42.)
 - If you are not using a CBL/DBS (cable TV or DBS tuner), the second (or third) VCR can be preset using the CBL/DBS position.
 - If you are not using a DVD player, the second (or third) VCR can be preset using the DVD MENU position. Note that in this case you must preset a code for an LD player to the DVD/LD position even if an LD player is not used.

Basic Operations

- Select the component that you want to control by turning the **SELECTOR DIAL**.
Note: Turn the **SELECTOR DIAL** until it stops with a click.

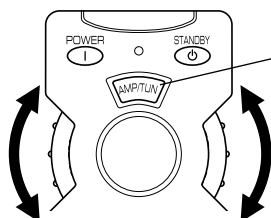

The component name is displayed in this window.

- Press the desired operation button.
Note: Press the button with the remote control transmitter aimed at the front panel.

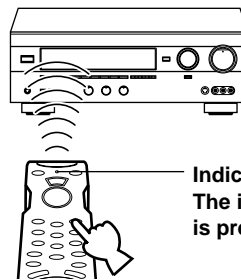

Indicator
The indicator will flash when the button is pressed.

Faintly colored buttons do not function.

AMP/TUN

Note: TV POWER and TV VOLUME function if you have preset the code for your TV.

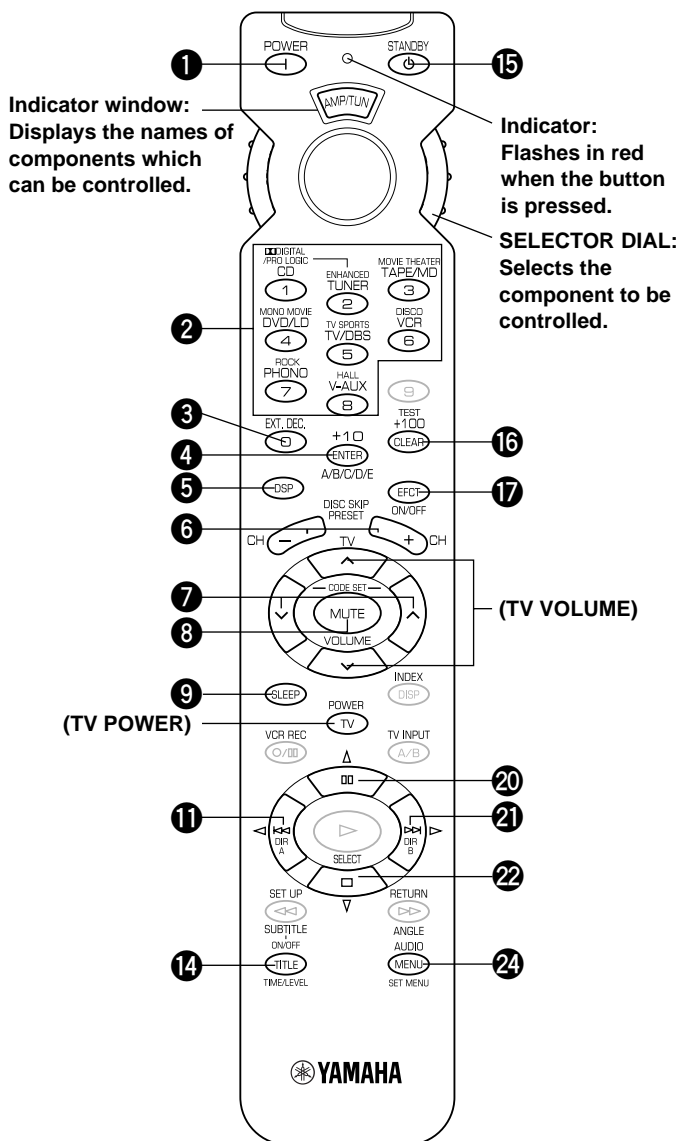

1 POWER

This button turns this unit on.

2 INPUT

Press these buttons to select the program source.

3 EXT. DEC.

Press this button when using an external decoder.

4 A/B/C/D/E

Press this button to select a group of preset stations when using the YAMAHA tuner.

5 DSP selector

Press this button. While the indicator lights up for about three seconds, select a DSP program using the number buttons (1 to 8). No DSP program can be selected after the indicator goes off.

6 PRESET (+/-)

Press these buttons to select the preset station number when using the YAMAHA tuner.

7 VOLUME (^ v)

Press these buttons to adjust the volume level.

8 MUTE

Press this button to mute the sound. To cancel mute, press this button once more, or press the operation buttons of this unit.

9 SLEEP

Press this button to set the SLEEP timer.

11 < (LEFT)

This button is used to adjust the settings of the SET MENU mode and the TIME/LEVEL mode.

14 TIME/LEVEL

Press this button to select the item in the TIME/LEVEL mode.

15 STANDBY

Press this button to turn this unit into Standby mode.

16 TEST

Press this button to output a test tone for adjusting the output level of the speakers.

17 EFCT (EFFECT) ON/OFF

Press this button to switch the DSP program on or off.

20 Δ (BACK)

Press this button to go back one selection in the SET MENU mode and TIME/LEVEL mode.

21 ▷ (RIGHT)

This button is used to adjust the settings of the SET MENU mode and the TIME/LEVEL mode.

22 ▽ (NEXT)

Press this button to advance one selection in the SET MENU mode and TIME/LEVEL mode.

24 SET MENU

Press this button to select functions in the SET MENU mode.

DSP

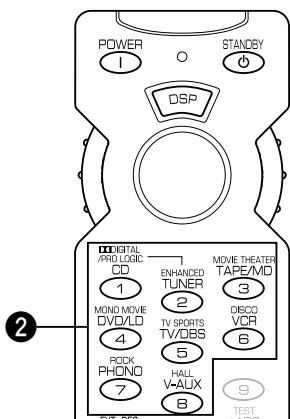

2 DSP program

Press these buttons to select the DSP program (1 to 8). When you select the input source, set the SELECTOR DIAL to the AMP/TUN position.

Note: The function of all buttons other than DSP program is the same as with the AMP/TUN position.



Faintly colored buttons do not function. For the buttons which are not described here, see "AMP/TUN" on page 38. For details, please refer to the owner's manual for each component.

TAPE/MD

Notes: • TV POWER and TV VOLUME function if you have preset the code for your TV.
• Be sure to preset the proper code for your MD recorder.

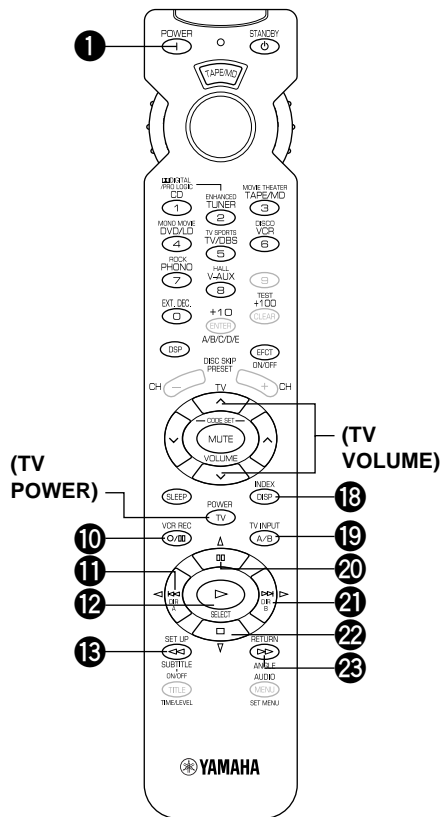

TAPE

1 POWER

This button turns this unit on under the default settings. (The code for a YAMAHA tape deck is preset as the default code.) If other codes are preset, only those preset tape decks having a remote controller with a POWER button will be turned on.

10 ○/⏸ (REC/PAUSE)

Press this button to pause recording on a tape deck.

11 ◀ DIR A

Press this button to select the playing direction of deck A.

12 ▶ (PLAY)

Press this button to play a tape.

13 ◀◀ (REWIND)

Press this button to rewind a tape.

19 DECK A/B

Press this button to select double cassette tape deck A or B.

21 ▶ DIR B

Press this button to select the playing direction of deck B.

22 □ (STOP)

Press this button to stop operation of a tape.

23 ▶▶ (FAST FORWARD)

Press this button to fast forward a tape.

MD

1 POWER

This button turns this unit on if you have preset the code for the YAMAHA MD recorder. If other codes are preset, only those MD recorders having a remote controller with a POWER button will be turned on.

10 ○/⏸ (REC/PAUSE)

11 ◀◀ (SKIP)

12 ▶ (PLAY)

13 ◀◀ (BACKWARD)

18 DISPLAY

20 □ (PAUSE)

21 ▶▶ (SKIP)

22 □ (STOP)

23 ▶▶ (FAST FORWARD)

CD

Note: TV POWER, TV VOLUME and TV INPUT function if you have preset the code for your TV.

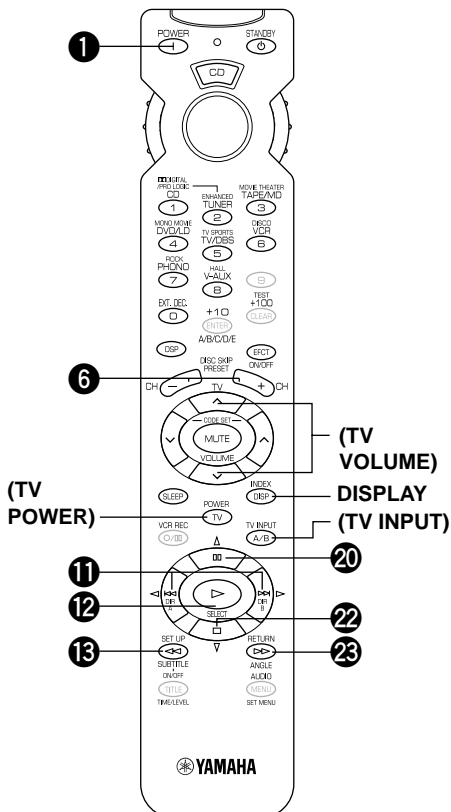

1 POWER

This button turns this unit on under the default settings. (The code for a YAMAHA CD player is preset as the default code.) If other codes are preset, only those CD players having a remote controller with a POWER button will be turned on.

6 DISC SKIP (+/-)

Press this button to skip to the next or previous CD.

11 ▶▶ , ◀◀ (SKIP)

Press ▶▶ to skip to the next track. Press ◀◀ to skip to the previous track.

12 ▶ (PLAY)

Press this button to play a CD.

13 ◀◀ (BACKWARD)

Press this button to backward the track that is playing.

20 □ (PAUSE)

Press this button to pause operation. This button functions as PAUSE/STOP for operating YAMAHA CD players under default settings.

22 □ (STOP)

Press this button to stop operation. This button functions as PAUSE/STOP for operating YAMAHA CD players under default settings.

23 ▶▶ (FAST FORWARD)

Press this button to fast forward the track that is playing.



Faintly colored buttons do not function. For the buttons which are not described here, see "AMP/TUN" on page 38. For details, please refer to the owner's manual for each component.

DVD/LD

POWER

(DVD) This button turns this unit on under the default settings. (The code for a YAMAHA DVD player is preset as the default code.) If other codes are preset, only those preset DVD players having a remote controller with a POWER button will be turned on.

(LD) This button turns this unit on if you have preset the code for the YAMAHA LD player. If other codes are preset, only those preset LD players having a remote controller with a POWER button will be turned on.

Note: TV POWER, TV VOLUME and TV INPUT function if you have preset the code for your TV.

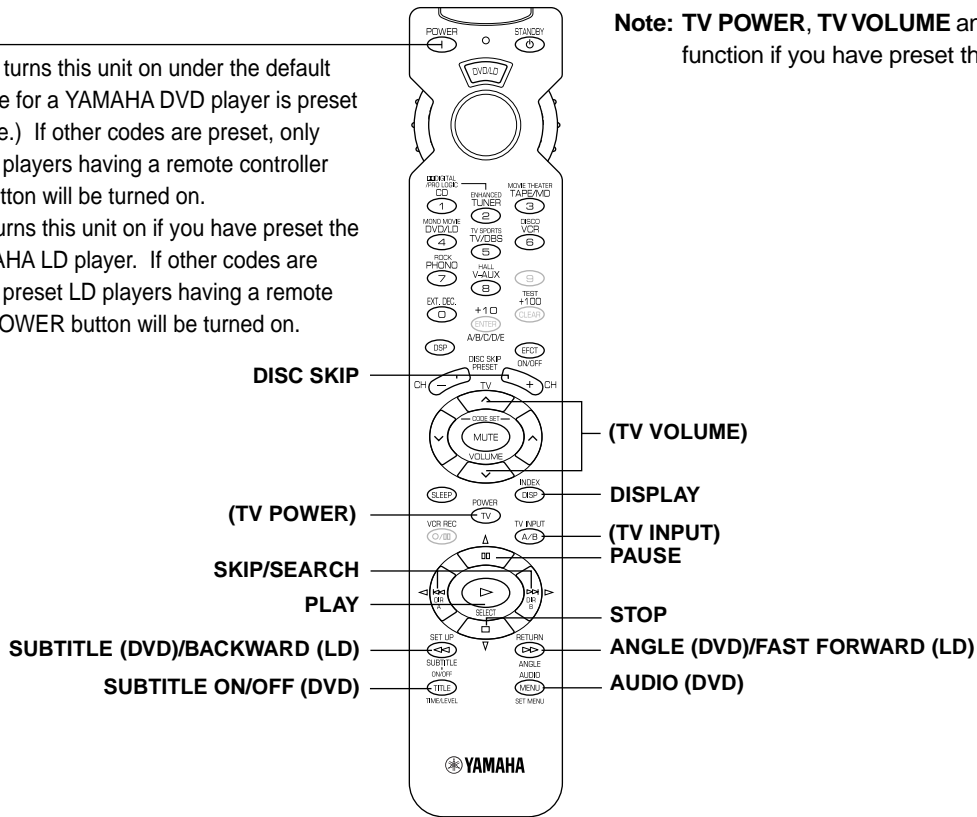

DVD MENU

POWER

(DVD) This button turns this unit on under the default settings. (The code for a YAMAHA DVD player is preset as the default code.) If other codes are preset, only those preset DVD players having a remote controller with a POWER button will be turned on.

Note: TV POWER, TV VOLUME and TV INPUT function if you have preset the code for your TV.

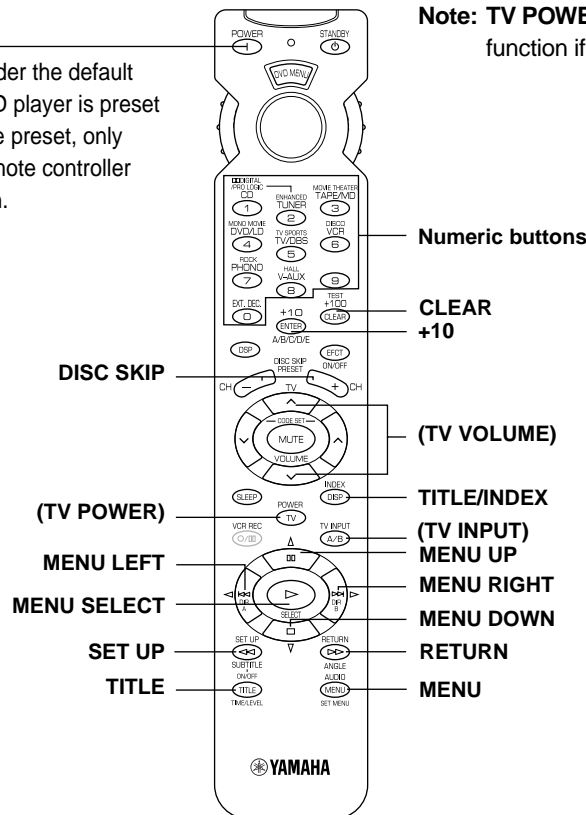



Faintly colored buttons do not function. For the buttons which are not described here, see "AMP/TUN" on page 38. For details, please refer to the owner's manual for each component.

VCR

Note: TV POWER, TV VOLUME and TV INPUT function if you have preset the code for your TV.

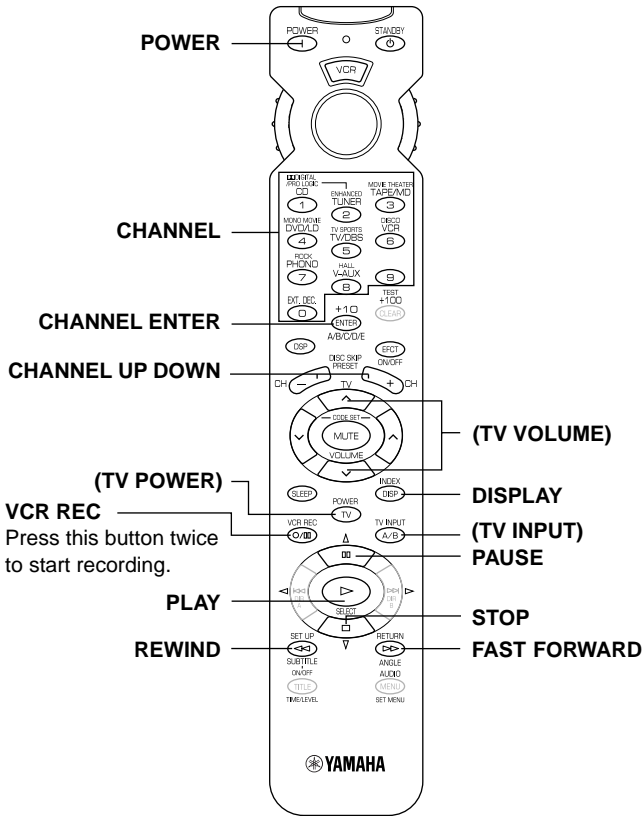

TV

Note: You can control your VCR if you have preset the code for it.

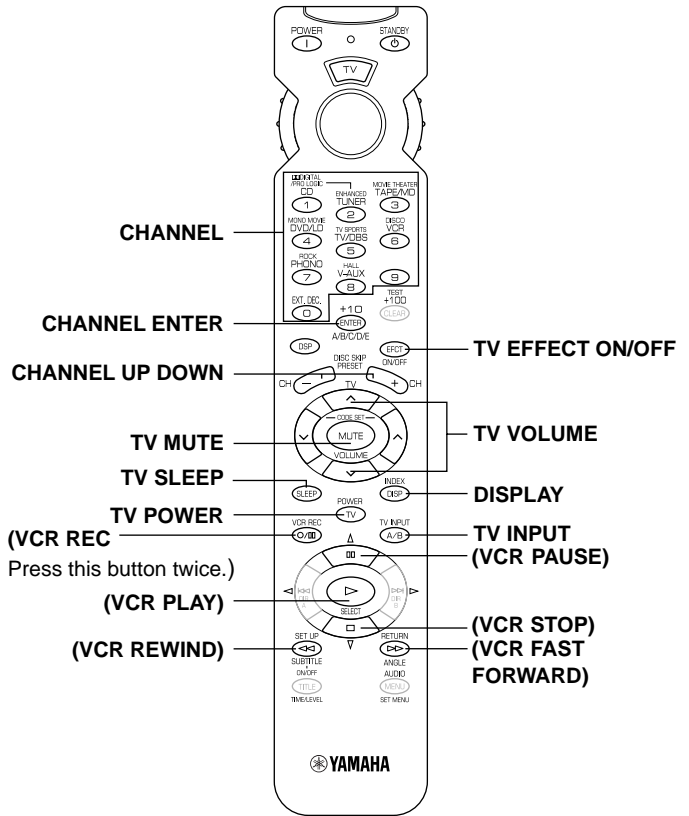

CBL/DBS

Note: TV POWER, TV VOLUME and TV INPUT function if you have preset the code for your TV.

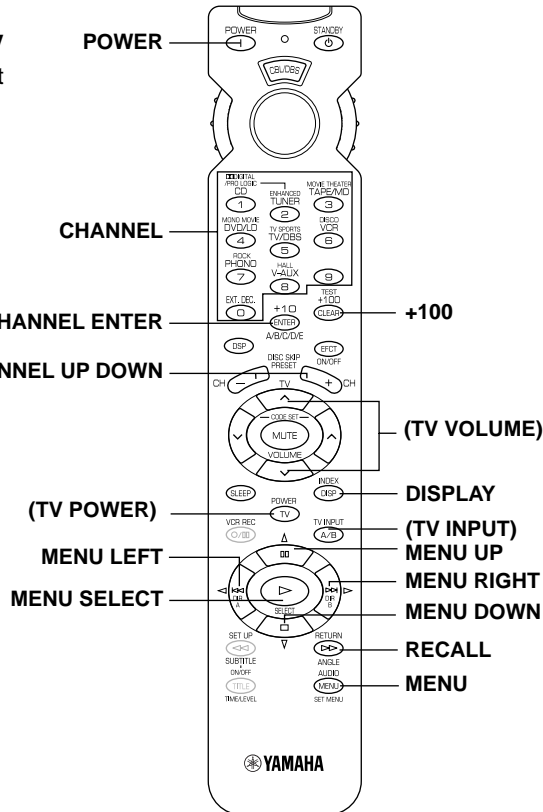



SETUP CODES

Presetting the remote control transmitter

Perform the presetting procedure for each component you want to control with this remote control transmitter.

Note: If your component does not respond to any of the codes listed for the manufacturer, use the original remote control that came with the component.

To control your components (MD recorder, DVD player, TV etc.)

1. Turn on the component to be used.
2. Set the **SELECTOR DIAL** to the desired component (TAPE/MD, DVD/LD, TV etc.).

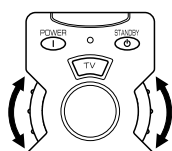

3. Press both **VOLUME** buttons (^) (v) at the same time until the indicator flashes twice.

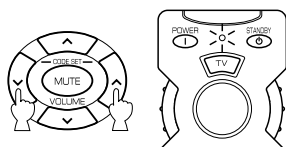

4. Use the numeric buttons to enter the four-digit manufacturer's code for the component to be used. Make sure that the indicator flashes twice. If the indicator does not flash, repeat step 3 and re-enter the code.

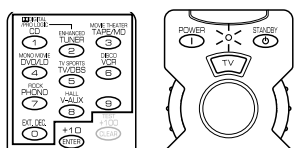

5. Press **POWER** (or any other button) on the remote control transmitter to check if you have preset the code correctly. If the component cannot be controlled using the remote control transmitter, try entering another code for the same manufacturer.

To use a second (and third) VCR

You can use the CBL/DBS and/or DVD MENU positions to control a second VCR (and/or third) if a CBL (or DBS) or DVD player is not used.

If you are using the DVD MENU position for a second (or third) VCR, you must preset a code for an LD player to the DVD/LD position.

1. Turn on the VCR to be used.
2. Set the **SELECTOR DIAL** to the CBL/DBS or DVD MENU position.

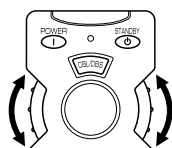

3. Press both **VOLUME** buttons (^) (v) at the same time until the indicator flashes twice.

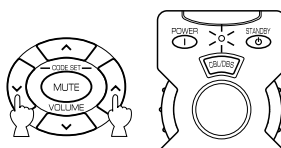

4. Press **MUTE**.

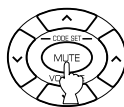

5. Use the numeric buttons to enter the four-digit code for a second (or third) VCR. Make sure that the indicator flashes twice. If the indicator does not flash, repeat step 3 and 4, and re-enter the code.

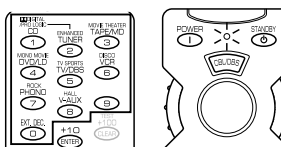

6. Press **POWER** (or any other button) on the remote control transmitter to check if you have preset the code correctly. If the VCR cannot be controlled using the remote control transmitter, try entering another code for the same manufacturer.

Returning to the default code

To return all components to the default code, follow these steps.

1. Press both **VOLUME** buttons (^) (v) at the same time until the indicator flashes twice.
2. Enter the code number "9987".
3. Make sure that the indicator flashes twice.

To return each component to the default code, follow these steps.

1. Set the **SELECTOR DIAL** to the component to be return to the default code.
2. Press both **VOLUME** buttons (^) (v) at the same time until the indicator flashes twice.
3. Enter the code number "9999".
4. Make sure that the indicator flashes twice.

The following codes are preset as the default code.

Default codes

POSITION	Component	Code ¹	Code ²
TV	TV	0037	0047
CBL/DBS	DBS tuner	2455	2566
VCR	VCR	3072	3060
DVD/LD	DVD player	4545	YAMAHA
CD	CD player	6187	YAMAHA
TAPE/MD	Tape deck	8524	YAMAHA

*1: U.K. and Europe models

*2: China and General models

We recommend that you write all code numbers you have preset on the "Quick Reference Card".



NOTES ABOUT THE REMOTE CONTROL TRANSMITTER

Battery installation

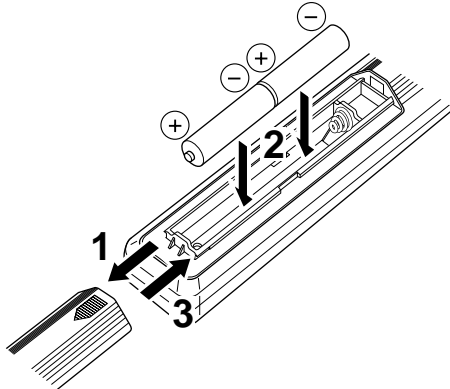

Remote control transmitter operation range

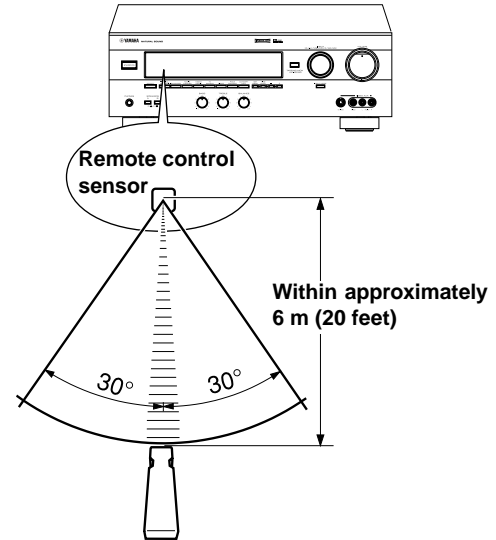

Battery replacement

If the remote control transmitter operates only when it is closed to this unit, the batteries are weak. Replace both batteries with new ones.

Be sure to replace batteries within about two minutes. If it takes longer than two minutes, the codes preset for the remote control transmitter will return to the default codes.

Notes

- Use only AA, R6, UM-3 batteries for replacement.
- Be sure the polarities are correct. (See the illustration inside the battery compartment.)
- Remove the batteries if the remote control transmitter will not be used for an extended period of time.
- If batteries leak, dispose of them immediately. Avoid touching the leaked material or letting it come in contact with clothing, etc. Clean the battery compartment thoroughly before installing new batteries.

Notes

- There should be no large obstacles between the remote control transmitter and this unit.
- If the remote control sensor is directly illuminated by strong lighting (especially an inverter type of fluorescent lamp etc.), it might cause the remote control transmitter not to work correctly. In this case, reposition this unit to avoid direct lighting.



TROUBLESHOOTING

If the unit fails to operate normally, check the following points to determine whether the fault can be corrected by the simple measures suggested. If it cannot be corrected, or if the fault is not listed in the SYMPTOM column, disconnect the power cord and contact your authorized YAMAHA dealer or service center for help.

	SYMPTOM	CAUSE	REMEDY
Amplifier	The unit fails to turn on when STANDBY/ON is pressed, or turns into the standby mode suddenly soon after the power is turned on.	Power cord is not plugged in or is not completely inserted.	Firmly plug in the power cord.
		The IMPEDANCE SELECTOR switch on the rear panel is not fully set to the upper or lower end.	Set the switch fully to the upper or lower end.
	The unit does not work normally.	There is an influence of strong external noise (lightning, excessive static electricity, etc.) or a misoperation while using this unit.	Turn this unit into the standby mode and disconnect the AC power cord from the AC outlet. After about 30 seconds have passed, connect the power and operate this unit again.
	No sound or no picture.	Incorrect output cord connections.	Connect the cords properly. If the problem persists, the cords may be defective.
		Appropriate input source is not selected.	Select an appropriate input source with INPUT .
		SPEAKERS are not set properly.	Set SPEAKERS corresponding to the speakers in use to the ON position.
		Speaker connections are not secure.	Secure the connections.
	No picture.	There is no S video terminal connection between this unit and the TV, though S video signals are input to this unit.	Connect this unit's S VIDEO MONITOR OUT terminal to the TV's S video input terminal.
	The sound suddenly goes off.	The protection circuit has been activated because of short circuit etc.	Turning the unit into the standby mode and then on again will reset the protection circuit.
		The SLEEP timer has functioned.	Cancel the SLEEP timer function.
	Only one side speaker outputs sound.	Incorrect setting of BALANCE .	Adjust it to the appropriate position.
		Incorrect cord connections.	Connect the cords properly. If the problem persists, the cords may be defective.
	A "humming" sound can be heard.	Incorrect cord connections.	Firmly connect the audio plugs. If the problem persists, the cords may be defective.
		No connection from the turntable to the GND terminal.	Make the GND connection between the turntable and this unit.
	The volume level is low while playing a record.	The record is being played on a turntable with an MC cartridge.	The turntable should be connected to the unit through the MC head amplifier.
	The volume level cannot be increased, or the sound is distorted.	The component connected to the REC OUT terminals of this unit is in the standby mode.	Turn the power to the component on.
	No sound from the rear speakers.	The sound output level of the rear speakers is set to minimum.	Raise the sound output level of the rear speakers.
		A monaural sound source is being played in DOLBY PRO LOGIC or DOLBY PRO LOGIC ENHANCED mode.	Select another sound field program suitable for the monaural sound source.
	No sound from the center speaker.	The sound output level of the center speaker is set to minimum.	Raise the sound output level of the center speaker.
		The center channel mode is in NONE mode.	Select LARGE or SMALL.
Incorrect sound field program selection.		Select the appropriate program.	



	SYMPTOM	CAUSE	REMEDY
Remote control transmitter	The remote control transmitter does not work.	Direct sunlight or lighting (of an inverter type of fluorescent lamp etc.) is striking the remote control sensor of the main unit.	Change the position of the main unit.
		The manufacturer's code is not set properly.	Set the code again.
		The proper manufacturer's code for the component to be controlled is not set.	Try entering another code for the same manufacturer.
		The component to be controlled is not selected.	Set the SELECTOR DIAL to the proper position.
Others	The sound is degraded when listening with headphones to a CD player or tape deck that is connected to this unit.	This unit is in the standby mode.	Turn the power of the unit on.



SPECIFICATIONS

AUDIO SECTION

Minimum RMS Output Power

MAIN L/R

8 ohms, 20 Hz to 20 kHz, 0.04% THD
..... 65 W + 65 W

CENTER

8 ohms, 20 Hz to 20 kHz, 0.04% THD
..... 65 W

REAR L/R

8 ohms, 20 Hz to 20 kHz, 0.04% THD
..... 65 W + 65 W

Maximum Power

[China and General models only]

MAIN L/R

8 ohms, 1 kHz, 10% THD
..... 105 W + 105 W

CENTER

8 ohms, 1 kHz, 10% THD 105 W

REAR L/R

8 ohms, 1 kHz, 10% THD
..... 105 W + 105 W

Dynamic Power per Channel

(by IHF Dynamic Headroom measuring method)

8/6/4/2 ohms 90/110/135/160 W

DIN Standard Output Power per Channel

[Europe model only]

4 ohms, 1 kHz, 0.7% THD 110 W

IEC Power

[Europe model only]

8 ohms, 1 kHz, 0.04% THD 75 W + 75 W

Power Band Width

8 ohms, 35 W, 0.1% THD
..... 10 Hz to 50 kHz

Damping Factor (SPEAKERS A)

8 ohms, 20 Hz to 20 kHz 60 or more

Input Sensitivity/Impedance

PHONO MM 2.5 mV/47 k-ohms

CD/TAPE-MD/DVD-LD/TV-DBS/VCR/

VIDEO AUX 150 mV/47 k-ohms

EXT. DECODER

MAIN L/R 150 mV/47 k-ohms

CENTER/SURROUND L/R/SUBWOOFER

..... 150 mV/40 k-ohms

Maximum Input Signal

PHONO MM

1 kHz, 0.1% THD 100 mV or more

CD/TAPE-MD/DVD-LD/TV-DBS/VCR/

VIDEO AUX (EFFECT ON)

1 kHz, 0.5% THD 2.2 V or more

Output Level/Impedance

REC OUT 150 mV/1.2 k-ohms

PRE OUT

[U.K. and Europe models only]

..... 2.1 V/1.2 k-ohms

SUBWOOFER

(MAIN SP: SMALL) 4.0 V/1.2 k-ohms

Headphones Jack Rated Output/Impedance

CD/TAPE-MD/DVD-LD/TV-DBS/VCR/

VIDEO AUX input,

1 kHz, 150 mV, 8 ohms 0.5 V/390 ohms

Frequency Response (20 Hz to 20 kHz)

CD/TAPE-MD/DVD-LD/TV-DBS/VCR/

VIDEO AUX to MAIN L/R SP OUT

..... 0±0.5 dB

RIAA Equalization Deviation

PHONO MM 0±0.5 dB

Total Harmonic Distortion (20 Hz to 20 kHz)

PHONO MM to REC OUT

1 V 0.02% or less

CD/TAPE-MD/DVD-LD/TV-DBS/VCR/

VIDEO AUX to MAIN L/R SP OUT

(EFFECT OFF)

8 ohms, 35 W 0.025% or less

Signal-to-Noise Ratio (IHF-A Network)

PHONO MM to REC OUT

(5 mV, Input Shorted)

[U.K. and Europe models]

..... 81 dB or more

[China and General models]

..... 86 dB or more

CD/TAPE-MD/DVD-LD/TV-DBS/VCR/

VIDEO AUX to SP OUT (EFFECT OFF)

(150 mV, Input Shorted) 96 dB or more

Residual Noise (IHF-A Network)

MAIN L/R SP OUT 150 µV or less

Channel Separation

(Vol. -30 dB, EFFECT OFF)

PHONO MM

(Input Shorted, 1 kHz/10 kHz)

..... 60 dB or more/55 dB or more

CD/TAPE-MD/DVD-LD/TV-DBS/VCR/

VIDEO AUX

(Input 5.1 k-ohms Terminated, 1 kHz/10 kHz)

..... 60 dB or more/45 dB or more

Tone Control Characteristics

BASS: Boost/cut ±10 dB (50 Hz)

Turnover Frequency 350 Hz

TREBLE: Boost/cut ±10 dB (20 kHz)

Turnover Frequency 3.5 kHz

Filter Characteristics

MAIN L/R, REAR L/R (SPEAKER: SMALL)

(H.P.F) fc = 90 Hz, 12 dB/oct.

SUBWOOFER

(L.P.F) fc = 90 Hz, 18 dB/oct.

VIDEO SECTION

Video Signal Type

[U.K. and Europe models] PAL

[China and General models] NTSC/PAL

Video Signal Level 1 Vp-p/75 ohms

S-Video Signal Level

Y 1 Vp-p/75 ohms

C 0.286 Vp-p/75 ohms

Maximum Input Level 1.5 Vp-p or more

Signal-to-Noise Ratio 50 dB or more

Monitor Out Frequency Response

..... 5 Hz to 10 MHz, -3 dB

GENERAL

Power Supply

[U.K. and Europe models]

..... AC 230 V, 50 Hz

[China model] AC 220 V, 50 Hz

[General model]

..... AC 110/120/220/240 V, 50/60 Hz

Power Consumption

[U.K. and Europe models] 300 W

[China and General models] 310 W

Maximum Power Consumption

[General model only]

5-ch, 10% THD 650 W

AC Outlets

3 SWITCHED OUTLETS

[China and General models]

..... 100 W max. total

2 SWITCHED OUTLETS

[Europe model] 100 W max. total

1 SWITCHED OUTLET

[U.K. model] 100 W max. total

Dimensions (W x H x D)

..... 435 x 151 x 391 mm

(17-1/8" x 5-15/16" x 15-3/8")

Weight 12.5 kg (27 lbs. 8 oz.)

Accessories Remote control transmitter

Batteries

Specifications are subject to change without

notice.



LIST OF MANUFACTURER'S CODES (U.K. and Europe models)
LISTE DES CODES FABRICANTS (Modèles Royaume-Uni et Europe)
VERZEICHNIS DER HERSTELLER CODES (Großbritannien- und Europa-Modell)
LISTA ÖVER TILLVERKARKODER (Modellerna för Storbritannien och övriga Europa)
ELENCO DEI CODICI DEL FABBRICANTE (Modelli per la Gran Bretagna e l'Europa)
LISTA DE CÓDIGOS DE FABRICANTES (Modelos para el Reino Unido y Europa)
LIJST VAN CODES VAN FABRIKANT (Modellen voor het Verenigd Koninkrijk en Europa)

TV

Manufacturer

Code

Abex 0032
Acura 0009
Admiral 0093, 0163, 0213
Adyson 0217, 0032
Akai 0208, 0361
Akura 0218, 0264, 0369
Alaron 0216
Alba 0037, 0218, 0371, 0009,
0036, 0235
Allorgan 0294
Amplivision 0217
Amstrad 0371, 0009, 0362, 0369
Anam 0009, 0068
Anitech 0009, 0068, 0076
Arcam 0216, 0217
Asberg 0076
Asuka 0218
Atlantic 0206
Audiosonic 0037, 0109
Autovox 0206, 0076, 0336
BPL 0282
BSR 0294
BTC 0218
Baird 0343
Basic Line 0218, 0009
Baur 0037, 0010, 0554, 0349, 0361
Beko 0370
Beon 0037
Binatone 0217
Blaupunkt 0554, 0191, 0195, 0200,
0213, 0327, 0328
Blue Sky 0218
Blue Star 0282
Bondstec 0247
Boots 0217
Brandt 0109, 0196, 0198,
0205, 0333, 0335
Brionvega 0362
Britannia 0216
Bush 0037, 0218, 0374, 0371, 0294,
0009, 0282, 0036, 0349
CCE 0037, 0217
CGE 0074, 0076, 0084, 0247, 0306
CS Electronics 0216
CTC 0247

Carrefour 0036
Cascade 0009
Cathay 0037
Centurion 0037
Century 0213
Cimline 0009
Clarivox 0037
Clatronic 0370, 0076, 0247
Condor 0370, 0320
Contec 0216, 0009, 0036, 0157
Continental Edison 0196, 0198,
0205, 0333
Crosley 0074, 0076, 0084, 0213
Crown 0037, 0370, 0418, 0009, 0076
Crystal 0431
Curtis Mathes 0093
Cybertron 0218
Daewoo 0037, 0374, 0009
Dainichi 0218, 0215
Dansai 0037
Dayton 0009
De Graaf 0208
Decca 0037, 0072
Dixi 0037, 0009
Dual 0336, 0352
Dual Tec 0217
Dumont 0070
Elbe 0259
Elin 0037
Elite 0218, 0320
Elta 0009
Emerson 0282, 0213, 0361
Erres 0037, 0012
Expert 0206
Ferguson 0037, 0109, 0005, 0073,
0190, 0238, 0287, 0335, 0343
Fidelity 0216, 0361
Finlandia 0208, 0346, 0359
Finlux 0037, 0072, 0070, 0105, 0346
Firstline 0216, 0217, 0294, 0009,
0321, 0247
Fisher 0370, 0217, 0208, 0303
Flint 0455
Formenti 0037, 0320, 0213
Frontech 0264, 0431, 0163, 0247
Fujitsu 0072, 0206
Funai 0294, 0264, 0303
GE 0282, 0093
GEC 0037, 0217, 0072, 0043, 0205

GPM 0218
Geloso 0009, 0213
Genexxa 0218, 0163
GoldStar 0037, 0217, 0109,
0032, 0290
Goodmans 0037, 0217, 0374, 0371,
0072, 0036, 0235, 0317, 0343
Gorenje 0370
Gradiente 0053
Graetz 0163, 0361
Granada 0037, 0217, 0072, 0146,
0208, 0339, 0359
Grandin 0282
Grundig 0037, 0554, 0070, 0191,
0195, 0205
HCM 0009, 0282
Hanseatic 0037, 0320, 0361
Harley Davidson 0043
Harvard 0068
Hinari 0037, 0218, 0009, 0036
Hisawa 0282, 0455
Hitachi 0217, 0036, 0109, 0032, 0043,
0044, 0105, 0163, 0196,
0198, 0225, 0306, 0349
Huanyu 0216, 0374
Hypson 0037, 0282, 0264
ICE 0217, 0371, 0264
ICeS 0218
ITS 0371
ITT 0163, 0361
Imperial 0370, 0418, 0074, 0076,
0084, 0247
Indiana 0037
Ingelen 0163
Inno Hit 0072
Interbuy 0068
Interfunk 0037, 0163, 0247, 0361
Intervision 0037, 0217, 0264,
0102, 0068
Isukai 0218
JVC 0371, 0036, 0053, 0190, 0192
KTV 0217
Kaisui 0216, 0217, 0218, 0009, 0282
Kamp 0216
Kapsch 0206, 0163
Kawasho 0216
Kendo 0037, 0235, 0362
Kingsley 0216
Kneissel 0259



Korpel	0037	Pathe Cinema	0216, 0320, 0213, 0238	Solavox	0032, 0163
Koyoda	0009	Pathe Marconi	0196, 0198, 0205, 0333	Sonitron	0208
Leyco	0037, 0294, 0072, 0264	Pausa	0009	Sonoko	0037, 0009
Liesenk & Tter	0037	Penney	0032	Sonolor	0163, 0208, 0215
Lloytron	0032	Perdio	0320	Sontec	0037
Loewe	0075	Phase	0032	Sony	0036, 0010, 0011
Luma	0206	Philco	0074, 0076, 0084, 0213, 0247	Soundwave	0037, 0418
Luxor	0349, 0361	Philips	0037, 0374, 0554, 0012, 0043, 0323	Standard	0217, 0218, 0009
M Electronic	0037, 0217, 0374, 0009, 0109, 0068, 0105, 0163, 0287, 0346	Phonola	0037, 0012	Stern	0206, 0163, 0259
MGA	0150	Pioneer	0109, 0163, 0287	Sunkai	0294, 0321
MTC	0216, 0349	Profex	0009, 0076, 0361	Susumu	0218
Magnadyne	0102, 0247	Proline	0321	Sysline	0037
Magnafon	0102, 0076, 0213	Protech	0037, 0217, 0418, 0009, 0264, 0102, 0431, 0247, 0337	Tandy	0217, 0218, 0072, 0093, 0163
Magnavox	0036	Pye	0012	Tashiko	0217, 0036, 0043, 0359
Manesth	0217, 0320, 0264, 0235	Quasar	0250	Tatung	0037, 0217, 0072
Marantz	0037	Quelle	0037, 0010, 0554, 0011, 0070, 0074, 0084, 0200, 0213, 0306, 0327, 0328, 0361	Tec	0217, 0247
Mark	0037	Questa	0036	Technema	0320
Matsui	0037, 0217, 0371, 0294, 0009, 0072, 0036, 0035, 0011, 0208, 0235	R-Line	0037	Technics	0250
Matsushita	0250	RBM	0070	Teknika	0150
McMichael	0043	RCA	0090, 0093	Teleavia	0205, 0333, 0343
Mediator	0037, 0012	Radio Shack	0032	Telefunken	0109, 0005, 0074, 0084, 0101, 0213, 0262, 0306, 0335, 0343
Memorex	0009, 0250, 0150	Radiola	0037, 0012, 0323	Telemeister	0320
Memphis	0337	Rank Arena	0036	Teletech	0009
Metz	0213, 0367	Realistic	0032	Teleton	0217, 0206, 0349
Midland	0032	Rediffusion	0361	Tensai	0218, 0294, 0320, 0317
Minerva	0554, 0070	Revox	0037	Texet	0216, 0218
Minoka	0369	Rex	0206, 0264, 0163, 0259	Thomson	0109, 0196, 0198, 0205, 0287, 0333, 0343, 0349
Mitsubishi	0036, 0093, 0108, 0150	Rhapsody	0216	Thorn	0037, 0072, 0035, 0074, 0084, 0190, 0192, 0361
Mivar	0216, 0290, 0291, 0292	Roadstar	0218, 0418, 0009, 0264	Thorn-Ferguson	0343
Motion	0076	SBR	0037, 0012, 0043	Tomashi	0282
Motorola	0093	SEG	0217, 0264, 0036, 0076	Toshiba	0036, 0035, 0070, 0243
Multitech	0216, 0217, 0009, 0102, 0076	SEI	0294, 0102, 0213	Trical	0157
NEC	0455, 0036	Saba	0109, 0075, 0163, 0196, 0198, 0205, 0213, 0287, 0335, 0343	Triumph	0243
NEI	0037, 0431, 0337	Saccs	0238	Uher	0206, 0320, 0303
Neckermann	0037, 0554, 0191, 0213, 0349	Saisho	0009, 0264, 0431, 0011, 0235	Ultra	0192
Nikkai	0037, 0216, 0218, 0072, 0264, 0035, 0032, 0337	Salora	0163, 0349, 0359, 0361	Ultravox	0102
Nikko	0317	Sambers	0102, 0076, 0213	Universum	0037, 0370, 0264, 0105, 0346
Noblisko	0102, 0076	Sampo	0032	Vestel	0037
Nokia	0361	Samsung	0037, 0370, 0217, 0009, 0264, 0032, 0090, 0290	Victor	0053
Nordmende	0109, 0196, 0198, 0213, 0287, 0343	Sandra	0216	Videosat	0247
Oceanic	0163, 0215, 0361	Sanyo	0072, 0036, 0011, 0146, 0157, 0208, 0213, 0339	Videotechnic	0217
Optimus	0250	Schaub Lorenz	0361	Vidtech	0036
Optonica	0093	Schneider	0037, 0218, 0371, 0247, 0303, 0323, 0336, 0352	Vision	0320
Orion	0037, 0294, 0320, 0321, 0235	Sears	0146	Voxson	0163
Osaki	0217, 0218, 0072, 0264, 0032	Sei-Sinudyne	0010	Waltham	0217
Oso	0218	Seleco	0206, 0163, 0259, 0362	Watson	0037, 0320
Osume	0072, 0032, 0157	Sentra	0035	Watt Radio	0102
Otake	0317	Sharp	0036, 0093, 0157	Wega	0036
Otto Versand	0037, 0217, 0320, 0036, 0010, 0554, 0191, 0213, 0343, 0349	Shorai	0294	White Westinghouse	0037, 0216, 0320
Palladium	0370, 0418	Siarem	0102, 0213	Yoko	0037, 0217, 0264, 0431
Panama	0217, 0264	Siemens	0037, 0554, 0157, 0191, 0195, 0200, 0213, 0327, 0328	Zanussi	0206
Panasonic	0250, 0163, 0213, 0214, 0226, 0367	Silver	0036		
		Sinudyne	0294, 0102, 0213, 0235		



CABLE

Manufacturer Code

ABC	1003, 1008, 1014, 1017
Birmingham Cable Communications	1276
British Telecom	1003, 1105
Cabletime	1161, 1271, 1377
Clyde	1086
Contec	1019
Decsat	1423
Filmnet	1443
France Telecom	1451
GEC	1086
General Instrument	1276
GoldStar	1144
Jerrold	1003, 1276, 1014
MNet	1443, 1019
Magnavox	1032
Memorex	1000
Movie Time	1156
NSC	1156
Oak	1019
PVP Stereo Visual Matrix	1003
Panasonic	1000
Paragon	1000
Pioneer	1144, 1260
Pulsar	1000
Runco	1000
STS	1156
Salora	1382
Samsung	1144
Satbox	1375
Scientific Atlanta	1008, 1277, 1017
Starcom	1003
Tele+1	1443
Teleservice	1281
Toshiba	1000
Tudi	1286
United Cable	1003
Videoway	1250
Westminster	1105
Zenith	1000

DBS TUNER

Manufacturer Code

AST	2321, 2351
Alba	2455, 2421, 2362, 2613
Aldes	2288
Allantide	2333
Amstrad	2080, 2252, 2345, 2461, 2501
Ankaro	2369, 2288, 2220, 2519, 2217
Anttron	2421, 2183
Arcon	2368
Armstrong	2243
Astra	2108, 2539

Astro	2520, 2173, 2358, 2501	Kyostar	2421
Avalon	2396	La Sat	2520, 2513, 2464
Axis	2369, 2530	Lemon	2692
BT	2668	Lenco	2421, 2335
Barcom	2217	Lennox	2592
Beko	2189	Lupus	2369
Best	2369, 2217	Luxor	2573, 2108
Blaupunkt	2173	Manhattan	2455, 2592, 2520
Boca	2243, 2513	Marantz	2200
Brain Wave	2332	Maspro	2092, 2328, 2336
Bush	2067	Matsui	2571, 2344
CNT	2520	Mediamarkt	2243
Cambridge	2344	Micro Technology	2333, 2539
Channel Master	2362	Minerva	2571
Chaparral	2053, 2209	Morgan's	2243, 2513
CityCom	2394	Multistar	2331, 2464
CommLink	2288	Muratto	2335
Connexions	2396	Navex	2332
Crown	2243	Neuhaus	2501
Cyrus	2200	Neusat	2692, 2834
D-box	2723	Newhaus	2220
DDC	2362	Nikko	2360
DNT	2396, 2200	Nokia	2455, 2573, 2108, 2328, 2397, 2873
Diskxpress	2217	Nordmende	2362
Drake	2268	Orbitech	2501
EIF	2417	Oxford	2344
Echostar	2396, 2871	Pace	2455, 2183, 2067, 2328, 2336, 2791
Emanon	2421	Palcom	2297
FTE	2331	Palladium	2571
Ferguson	2183, 2067, 2189, 2336	Palsat	2501
Fidelity	2252	Panda	2455
Finlux	2455, 2108, 2344, 2397	Philips	2455, 2571, 2200, 2292, 2328
Fracarro	2871	Phonotrend	2288, 2592
Freecom	2421, 2335	Planet	2871
Fuba	2421, 2369, 2396, 2217, 2297, 2417	Plasmatic	2442
G-Sat	2183	Polytron	2394
Galaxis	2288, 2834, 2863	Promax	2455
Galaxisat	2321	Prosat	2288
GoldStar	2335	Quadral	2362, 2519
Gooding	2571	RFT	2288, 2220, 2200
Goodmans	2189	Radiola	2200
Grothusen	2335	Radix	2396, 2882
Grundig	2571, 2173, 2189, 2328	SAT	2321, 2351, 2461
Harting und Helling	2333	SEG	2421, 2369, 2539
Hinari	2183	STVI	2417
Hirschmann	2502, 2173, 2573, 2287, 2333, 2397, 2398	Saba	2520, 2336
Hitachi	2455	Sabre	2455
Houston	2668	Sagem	2820
Huth	2243, 2288, 2220, 2346	Salora	2108
ITT	2108	Samsung	2287
InVideo	2871	SatPartner	2421, 2332, 2520, 2502, 2335, 2692
Intervision	2592	Satcom	2605, 2346
JVC	2571	Satec	2183, 2328
Johansson	2332	Satmaster	2346
Kathrein	2173, 2200, 2092, 2331, 2358, 2394, 2442, 2480, 2504	Schwaiger	2183, 2394, 2504
Kosmos	2331, 2335	Seemann	2396, 2530
Kreiselmeyer	2173	Siemens	2173



Skymaster	2288, 2605, 2519
Star Trak	2421
Strong	2421
Sunstar	2513
TPS	2820
Tantec	2455, 2297, 2336
TechniSat	2262, 2501
Techniland	2346
Telefunken	2421
Teleka	2243, 2613
Telesat	2605
Thomson	2455
Tonna	2668, 2346
Triad	2321, 2333, 2335, 2351
Triasat	2501
Unitor	2332, 2217
Universum	2571, 2173
Vector	2333
Ventana	2200
Vortec	2421
Vtech	2351
Wevasat	2333
Winersat	2332
Wisi	2455, 2396, 2173, 2321, 2351, 2372, 2406, 2407
XSat	2889
Xcom Multimedia	2889
Zehnder	2520, 2321, 2331

CGE	3000
Calix	3037
Capehart	3020
Carver	3081
Catron	3020
Cimline	3072
Cineral	3278
Citizen	3037, 3278
Clatronic	3020
Colt	3072
Combitech	3352
Condor	3020
Craig	3072, 3037, 3047, 3240
Crown	3072, 3020, 3278
Curtis Mathes	3041, 3162
Cybernex	3240
Cyrus	3081
Daewoo	3020, 3278, 3045
Dansai	3072
Daytron	3020
De Graaf	3042, 3166
Decca	3000, 3081
Denon	3042
Dual	3041
Dumont	3000, 3081, 3104
Dynatech	3000
ESC	3278, 3240
Elbe	3038
Elcatech	3072
Electrohome	3037
Electroponic	3037
Emerex	3032
Emerson	3000, 3037, 3278, 3209, 3036, 3043, 3088
Ferguson	3320, 3041, 3107, 3321
Fidelity	3000
Finlandia	3081, 3104
Finlux	3000, 3081, 3042, 3104
Firstline	3072, 3037, 3209, 3045, 3043
Fisher	3046, 3047, 3054, 3104
Frontech	3020
Fuji	3033
Funai	3000
GE	3048, 3240
GEC	3081
Garrard	3000
General	3020
Go Video	3432
GoldHand	3072
GoldStar	3037, 3038, 3225
Goodmans	3072, 3000, 3020, 3037, 3278, 3403
Gradiente	3000, 3008
Graetz	3005, 3041, 3104, 3240
Granada	3081, 3046, 3104
Grandin	3072, 3000, 3037
Grundig	3072, 3081, 3347, 3226, 3195, 3003, 3006, 3007, 3207, 3349, 3403
HCM	3072
HI-Q	3047

Hanseatic	3037
Harley Davidson	3000
Harman/Kardon	3038
Harwood	3072
Headquarter	3046
Hinari	3072, 3004, 3240, 3352
Hitachi	3000, 3004, 3042, 3041, 3166, 3235, 3240
Hypson	3072
ITT	3106, 3046, 3384, 3005, 3041, 3104, 3240
ITV	3037, 3278
Imperial	3000
Ingersol	3004
Interfunk	3081
JVC	3067, 3384, 3008, 3041, 3206, 3207, 3486
Jensen	3041
KEC	3037, 3278
KLH	3072
Kaisui	3072
Kendo	3209, 3106
Kenwood	3067, 3384, 3038, 3041
Kodak	3037
Korpel	3072
LXI	3037
Lenco	3278
Leyco	3072
Lloyd's	3000
Loewe	3037, 3004, 3081, 3006
Logik	3072, 3004, 3240
Luxor	3106, 3048, 3046, 3043, 3104
M Electronic	3000
MGA	3043, 3240
MGN Technology	3240
MTC	3000, 3240
Magnasonic	3278
Magnavox	3000, 3081
Magnin	3240
Manesth	3072, 3045
Marantz	3081, 3003, 3006
Marta	3037
Matsui	3209, 3004, 3036, 3088, 3348, 3352
Matsushita	3162
Memorex	3000, 3037, 3048, 3046, 3047, 3104, 3162, 3240, 3307
Memphis	3072
Metz	3347, 3195, 3003, 3006, 3162, 3227
Minerva	3195, 3006
Minolta	3042
Mitsubishi	3081, 3067, 3048, 3043
Motorola	3048
Multitech	3072, 3000
Murphy	3000
NEC	3067, 3038, 3041, 3104
Neckermann	3081
Nesco	3072
Nikko	3037
Nikon	3034

VCR

Manufacturer	Code
ASA	3037, 3081
Admiral	3048
Adventura	3000
Aiko	3278
Aiwa	3000, 3037, 3307, 3348, 3352
Akai	3315, 3106, 3041, 3053
Akiba	3072
Alba	3072, 3020, 3278, 3209, 3315, 3352
Ambassador	3020
Amstrad	3000, 3278, 3325, 3332
Anitech	3072
Asha	3240
Asuka	3037
Audiovox	3037
Baird	3000, 3041, 3104, 3107
Basic Line	3072, 3020, 3278
Beaumarck	3240
Bell & Howell	3104
Blaupunkt	3034, 3226, 3195, 3003, 3006, 3154, 3162, 3227, 3403
Brandt	3320, 3187, 3321
Brandt Electronic	3041
Broksonic	3209
Bush	3072, 3278, 3209, 3352
CCE	3072, 3278





Noblex 3240
 Nokia 3106, 3046, 3041, 3104, 3240
 Nordmende 3320, 3384, 3041, 3297, 3321
 Oceanic 3000, 3041
 Okano 3315, 3348
 Olympus 3226
 Optimus 3037, 3432, 3048, 3104, 3162
 Orion 3209, 3004, 3036, 3088, 3348, 3352
 Osaki 3072, 3000, 3037
 Otto Versand 3081
 Palladium 3072, 3037, 3006, 3041
 Panasonic 3226, 3162, 3225, 3227
 Pathe Cinema 3036
 Pathe Marconi 3041
 Penney 3037, 3042, 3038, 3054, 3240
 Pentax 3042
 Perdio 3000
 Philco 3209, 3038
 Philips 3081, 3384, 3403
 Phonola 3081
 Pilot 3037
 Pioneer 3081, 3067, 3162, 3235
 Portland 3020
 Profex 3322
 Profitronic 3240
 Proline 3000
 Protec 3072
 Pye 3081
 Quarter 3046
 Quartz 3046
 Quasar 3162
 Quelle 3081
 RCA 3106, 3042, 3048, 3240
 RFT 3403
 Radio Shack 3000, 3037
 Radiola 3081
 Radix 3037
 Randex 3037
 Realistic 3000, 3037, 3048, 3046, 3047, 3104
 Rex 3384, 3041
 Ricoh 3034
 Roadstar 3072, 3037, 3278, 3240
 SBR 3081
 SEG 3322, 3240
 SEI 3004, 3081
 STS 3042
 Saba 3320, 3384, 3041, 3206, 3207, 3297, 3321
 Saisho 3209, 3004, 3036, 3088
 Salora 3106, 3046, 3043
 Samsung 3432, 3045, 3053, 3240
 Sanky 3048
 Sansui 3000, 3067, 3041
 Sanyo 3046, 3047, 3104, 3240
 Saville 3352
 Schaub Lorenz 3000, 3005, 3041, 3104
 Schneider 3072, 3000, 3081
 Scott 3045, 3043

Sears 3000, 3037, 3042, 3046, 3047, 3054, 3104
 Seleco 3041
 Semp 3045
 Sentra 3020
 Sharp 3048
 Shintom 3072, 3104
 Shogun 3240
 Shorai 3004
 Siemens 3037, 3081, 3195, 3003, 3006, 3054, 3104
 Silva 3037
 Singer 3072, 3045
 Sinudyne 3004, 3081
 Solavox 3020
 Sonolor 3046
 Sontec 3037
 Sony 3000, 3032, 3033, 3034, 3011
 Sunkai 3348
 Sunstar 3000
 Suntronic 3000
 Sylvania 3000, 3081, 3043
 Symphonic 3000
 TMK 3036, 3240
 Tashiko 3000
 Tatung 3000, 3081, 3041
 Teac 3000, 3041
 Tec 3020
 Technics 3226, 3162
 Teknika 3000, 3037
 Teleavia 3041
 Telefunken 3320, 3384, 3041, 3187, 3321
 Tenosal 3072
 Tensai 3322, 3000
 Thomas 3000
 Thomson 3320, 3384, 3041
 Thorn 3036, 3041, 3104
 Toshiba 3081, 3045, 3384, 3041, 3043
 Totevision 3037, 3240
 Towada 3322
 Uher 3240
 Unitech 3240
 Universum 3000, 3037, 3081, 3106, 3195, 3006, 3240, 3325
 Vector 3045
 Vector Research 3038
 Video Concepts 3045
 Videosonic 3240
 Wards 3072, 3000, 3081, 3042, 3048, 3047, 3240
 White Westinghouse 3278
 XR-1000 3072, 3000
 Yamaha 3038
 Yamishi 3072
 Yokan 3072
 Yoko 3020, 3240
 Zenith 3000, 3033, 3034

DVD PLAYER

Manufacturer	Code
Kenwood	4534
Magnavox	4503
Onkyo	4503
Panasonic	4490
Philips	4539, 4503
Pioneer	4525
Sony	4533
Technics	4490
Thomson	4551
Toshiba	4503
Yamaha	4490, 4545
Zenith	4503

LD PLAYER

Manufacturer	Code
Aiwa	5203
Carver	5064, 5194
Cyrus	5388
Denon	5059, 5172
Disco Vision	5023
Funai	5203
Hitachi	5023
Magnavox	5194, 5217
Marantz	5064, 5194
Mitsubishi	5059
NAD	5059
Panasonic	5204, 5496
Philips	5064, 5388, 5194
Pioneer	5023, 5059
Quasar	5204
Radiola	5388
Realistic	5203
Salora	5064
Sega	5023
Sharp	5001
Sony	5193, 5201
Technics	5204, 5496
Telefunken	5059
Theta Digital	5194
Thorn	5014
Yamaha	5217



CD PLAYER

Manufacturer	Code
Aiwa	6124, 6157, 6419
Akai	6108, 6156, 6199
Alba	6536, 6288, 6334
Arcam	6157
Audio Research	6157
Audio Ton	6157
Audiolab	6157
Audiomeca	6157
BSR	6134
Bestar	6164
Binatone	6452
California Audio Lab	6029
Carver	6157, 6179
Condor	6134, 6164
Cyrus	6157
DKK	6000
Denon	6003, 6034
Dual	6196
Emerson	6164
Fisher	6048, 6179, 6342
GE	6334
Genexxa	6032, 6164
GoldStar	6525, 6383
Goodmans	6536
Grundig	6157
Harman/Kardon	6108, 6173
Hitachi	6032, 6291
JVC	6072
Kenwood	6037, 6523, 6028, 6048, 6190
Kodak	6287
Krell	6157
Linn	6157
Luxman	6328
M Electronic	6525
MCS	6029
Magnavox	6157, 6038, 6129
Marantz	6157, 6029, 6038, 6129
Matsui	6157, 6288, 6307
McIntosh	6287

Memorex	6032, 6164
Meridian	6157
Micromega	6157
Mission	6157
Mitsubishi	6108, 6156
NAD	6000
NSM	6157
Naim	6157
Nikko	6525, 6164
Onkyo	6101, 6102
Optimus	6000, 6032, 6037, 6536, 6048, 6179, 6196, 6342
Panasonic	6303, 6029, 6367
Philips	6157, 6274, 6287
Pioneer	6032
Poppy	6164
Proton	6157
QED	6157
Quad	6157
Quasar	6029
RCA	6179
Realistic	6164, 6179
Revox	6157, 6113
Roadstar	6461, 6525, 6527
Rotel	6157
SAE	6157
Sansui	6157, 6202, 6513
Sanyo	6048, 6179, 6342
Schneider	6134
Scott	6164
Sharp	6037, 6262, 6265
Sherwood	6114, 6196
Siemens	6516
Signature	6108
Sony	6000, 6490
Teac	6378
Technics	6207, 6303, 6029
Toshiba	6481
Universum	6157
Victor	6072
Wards	6157, 6108
Yamaha	6036, 6082, 6187, 6712
Yorx	6461

MD RECORDER

Manufacturer	Code
Kenwood	7826
Sony	7490
Yamaha	7888, 7490

TAPE DECK

Manufacturer	Code
Aiwa	8029, 8197, 8200
Akai	8188, 8189
Arcam	8076
Carver	8029
Denon	8076, 8412
Fisher	8074
Grundig	8029
Harman/Kardon	8182
JVC	8244, 8273, 8274
Kenwood	8070, 8071, 8092, 8205, 8233, 8234
Magnavox	8029
Marantz	8029, 8009
Memorex	8099, 8101
Mitsubishi	8189
Onkyo	8136, 8135
Optimus	8027, 8220
Panasonic	8229
Philips	8029
Pioneer	8027, 8099, 8101, 8220
Revox	8029
Sansui	8029, 8009
Sanyo	8074
Sharp	8205
Sony	8170, 8243
Technics	8229
Victor	8273, 8274
Wards	8027
Yamaha	8094, 8097, 8205, 8478, 8524



LIST OF MANUFACTURER'S CODES (China and General models)
LISTE DES CODES FABRICANTS (Modèles pour la Chine et général)
VERZEICHNIS DER HERSTELLER CODES (China- und allgemeines Modell)
LISTA ÖVER TILLVERKARKODER (Modellen för Kina och den allmänna modellen)
ELENCO DEI CODICI DEL FABBRICANTE (Modelli per la Cina e generale)
LISTA DE CÓDIGOS DE FABRICANTES (Modelos para China y general)
LIJST VAN CODES VAN FABRIKANT (Modellen voor China en algemene modellen)

TV

Manufacturer

Code

A-Mark 0003
AOC 0030, 0019, 0003, 0052, 0185
Abex 0032
Acura 0009
Admiral 0093
Adventura 0046
Adyson 0032
Aiko 0092
Akai 0030, 0208
Akura 0264
Alaron 0179, 0216
Alba 0009, 0037
Ambassador 0177
Amstrad 0009, 0171, 0177
Anam 0180, 0004, 0009, 0068
Anam National 0161
Anitech 0009, 0068
Arcam 0216
Archer 0003
Audinac 0391
Audiosonic 0037, 0109
Audiovox 0451, 0180, 0003, 0092
BPL 0282
Basic Line 0009
Baur 0037, 0512, 0535, 0554
Baysonic 0180
Belcor 0019
Bell & Howell 0154, 0016
Beon 0037
Blaupunkt 0535, 0554
Blue Star 0282
Bradford 0180
Brandt 0109
Britannia 0216
Brockwood 0019
Broksonic 0236, 0463, 0003, 0426
Bush 0282, 0009, 0037
CCE 0037
CS Electronics 0216
CXC 0180
Candle 0030, 0056, 0046, 0186
Carnivale 0030
Carver 0054, 0170
Cascade 0009
Cathay 0037

Celebrity 0000
Centurion 0037
Cimline 0009
Cineral 0451, 0092
Citizen 0060, 0030, 0056, 0039, 0046, 0092, 0186, 0280
Clairtone 0185
Clarivox 0037
Concerto 0056
Contec 0180, 0009, 0185, 0216
Craig 0180, 0161
Crosley 0054
Crown 0180, 0039, 0009, 0037, 0418
Curtis Mathes 0047, 0054, 0154, 0051, 0451, 0093, 0060, 0030, 0145, 0056, 0016, 0039, 0166
Daewoo 0451, 0019, 0039, 0009, 0037, 0066, 0092
Dansai 0037
Dayton 0009
Daytron 0019
De Graaf 0208
Decca 0037
Denon 0145
Dixi 0004, 0009, 0037
Dumont 0017, 0019
Ectec 0391
Electroband 0000, 0185
Elin 0037
Elta 0009
Emerson 0154, 0236, 0463, 0180, 0282, 0178, 0019, 0179, 0039, 0177, 0185, 0280
Envision 0030
Erres 0037
Ferguson 0037, 0109, 0287, 0560
Fidelity 0216
Finlandia 0208
Finlux 0179, 0037
Firstline 0009, 0216
Fisher 0154, 0159, 0208
Formenti 0037
Frontech 0264
Fujitsu 0179
Funai 0180, 0179, 0171, 0264
Futuretech 0180
GE 0047, 0051, 0451, 0093, 0282, 0178, 0021, 0135
GEC 0037
Geloso 0009

Gibraltar 0017, 0030, 0019
GoldStar 0030, 0178, 0019, 0056, 0001, 0002, 0032, 0037, 0109
Goodmans 0179, 0037
Gradiente 0053, 0056, 0170
Granada 0037, 0208, 0339, 0502
Grandin 0282
Grundig 0037, 0535, 0554
Grunpy 0180, 0179
HCM 0282, 0009
Hallmark 0178
Hanseatic 0037
Harley Davidson 0179
Harvard 0180, 0068
Hinari 0179, 0009, 0037, 0283
Hisawa 0282
Hitachi 0145, 0056, 0032, 0109, 0151, 0576
Huanyu 0216
Hypson 0282, 0037, 0264
ICE 0264
ITT 0283
Imperial 0418
Indiana 0037
Infinity 0054
Inteq 0017
Interbuy 0068
Interfunk 0037, 0512
Intervision 0037, 0068, 0264
JBL 0054
JCB 0000
JEC 0502
JVC 0053, 0069, 0160
Janeil 0046
KEC 0180
KTV 0180, 0030, 0039, 0185, 0280
Kaisui 0282, 0009, 0216
Kamp 0216
Kawasho 0216
Kaypani 0052
Kendo 0037
Kenwood 0030, 0019
Kingsley 0216
Kloss 0046
Korpel 0037
Koyoda 0009
LG 0056
LXI 0047, 0054, 0154, 0156, 0178
Leyco 0037, 0264
Liesenk & Tter 0037



Lloytron	0032	Phonola	0037	Soundesign	0180, 0178, 0179, 0186
Loewe	0512	Pilot	0030, 0019, 0039	Soundwave	0037, 0418
Logik	0016, 0001	Pioneer	0109, 0166, 0287	Spectricon	0003
Luxman	0056	Portland	0019, 0039, 0092	Squareview	0171
M Electronic	0009, 0037, 0068, 0109, 0287	Prism	0051	Standard	0009
MEI	0185	Profex	0009	Starlite	0180
MGA	0150, 0030, 0178, 0019	Proscan	0047	Supra	0056
MTC	0060, 0030, 0019, 0056, 0185, 0216, 0512	Protech	0009, 0037, 0264, 0418	Supre-Macy	0046
Magnavox	0054, 0030, 0179, 0186, 0187	Proton	0178, 0003, 0052	Supreme	0000
Majestic	0016	Pulsar	0017, 0019	Sylvania	0054, 0030
Manesth	0264	Quasar	0051, 0250, 0165	Symphonic	0171
Marantz	0054, 0030, 0037	Quelle	0037, 0252, 0512, 0535, 0554	Sysline	0037
Mark	0037	R-Line	0037	TMK	0178, 0056, 0177
Matsui	0009, 0035, 0037, 0177, 0208	RCA	0047, 0051, 0093, 0019, 0018, 0090, 0135	Tandy	0093
Matsushita	0250	Radio Shack	0047, 0154, 0165, 0180, 0030, 0178, 0019, 0056, 0039, 0032	Tatung	0003, 0037
Mediator	0037	Radiola	0037	Technics	0051, 0250
Megatron	0178, 0145, 0003	Realistic	0154, 0165, 0180, 0030, 0178, 0019, 0056, 0039, 0032	Technol Ace	0179
Memorex	0154, 0250, 0150, 0178, 0056, 0016, 0009	Revox	0037	Techwood	0051, 0056, 0003
Metz	0535	Rex	0264	Teknika	0054, 0180, 0150, 0060, 0019, 0179, 0056, 0016, 0039, 0092, 0186
Midland	0047, 0017, 0051, 0039, 0032, 0135	Rhapsody	0185, 0216	Telefunken	0056, 0109, 0252
Minerva	0535, 0554	Roadstar	0009, 0264, 0418	Teletech	0009
Minutz	0021	Runco	0017, 0030	Teleton	0186
Mitsubishi	0093, 0150, 0178, 0019, 0512, 0535	SBR	0037	Textet	0216
Mivar	0216	SEG	0264	Thomson	0109, 0287
Motorola	0093	SEI	0177	Thorn	0035, 0037, 0512, 0535
Multitech	0180, 0009, 0216	SSS	0180, 0019	Tomashi	0282
NAD	0156, 0178, 0166	Saba	0109, 0287	Toshiba	0154, 0156, 0060, 0035, 0149, 0502
NEC	0030, 0019, 0056, 0170	Saisho	0009, 0177, 0264	Tosonic	0185
NEI	0037	Sampo	0030, 0039, 0032, 0052	Totevision	0039
NTC	0092	Samsung	0060, 0030, 0178, 0019, 0056, 0039, 0009, 0032, 0037, 0090, 0264, 0427	Triumph	0177
Neckermann	0037, 0554	Samsux	0039	Ultra	0391
Nesco	0179	Sandra	0216	Universum	0037, 0264, 0535
Nikkai	0032, 0035, 0037, 0216, 0264	Sansei	0451	Vector Research	0030
Nikko	0030, 0178, 0092	Sansui	0463	Vestel	0037
Nisato	0391	Sanyo	0154, 0159, 0208, 0339	Victor	0053
Nordmende	0109, 0287, 0560	Schneider	0037	Vidikron	0054
Noshi	0018	Scimitsu	0019	Vidtech	0178, 0019
Onwa	0180	Scotch	0178	Viking	0046
Optimus	0154, 0250, 0166	Scott	0236, 0180, 0178, 0019, 0179	Wards	0054, 0165, 0030, 0178, 0021, 0019, 0179, 0056, 0016, 0080
Optonica	0093, 0165	Sears	0047, 0054, 0154, 0156, 0178, 0179, 0056, 0149, 0159, 0171	Watson	0037
Orion	0236, 0463, 0179, 0037, 0177	Semivox	0180	White Westinghouse	0037, 0216
Osaki	0032, 0264	Semp	0156	Yamaha	0030, 0019
Osume	0032	Sentra	0035, 0283	Yoko	0037, 0264
Otto Versand	0037, 0512, 0535, 0554	Sharp	0093, 0165, 0039	Zenith	0017, 0016, 0092
Palladium	0418	Shogun	0019	Zonda	0003
Panama	0264	Siemens	0037, 0535, 0554		
Panasonic	0051, 0250, 0226	Signature	0016		
Pathe Cinema	0216	Simpson	0186, 0187		
Pausa	0009	Sinudyne	0177		
Penney	0047, 0156, 0051, 0060, 0030, 0178, 0021, 0019, 0018, 0056, 0039, 0002, 0003, 0032, 0135, 0149	Solavox	0032		
Phase	0032	Sonitron	0208		
Philco	0054, 0463, 0030, 0145, 0019	Sonoko	0009, 0037		
Philips	0054, 0037, 0554	Sonolor	0208		
		Sontec	0037		
		Sony	0000, 0080		



CABLE

Manufacturer	Code
ABC	1003, 1008, 1014, 1011
Allegro	1315
Archer	1797
BBT	1267
Belcor	1056
British Telecom	1003
Cable Star	1056
Citizen	1315
Colour Voice	1031
Comtronics	1040
Contec	1019
Emerson	1797
Everquest	1015, 1040
Focus	1400
GC Electronics	1056
Gemini	1015
General Instrument	1476, 1011
GoldStar	1144, 1040
Goodmind	1797
Hamlin	1020, 1259, 1009, 1034
Hitachi	1011
Jasco	1315
Jerrold	1003, 1012, 1476, 1014, 1015, 1011, 1024
MNet	1019
Magnavox	1027
Memorex	1000
Movie Time	1063
NSC	1063
Novaplex	1618
Oak	1019
Optimus	1021
PVP Stereo Visual Matrix	1003
Panasonic	1000, 1107, 1021
Paragon	1000
Philips	1027, 1031
Pioneer	1144, 1533
Popular Mechanics	1400
Prelude	1770
Pulsar	1000
RCA	1021
Radio Shack	1015, 1315
Recoton	1400
Regal	1020, 1259
Rembrandt	1011
Runco	1000
SL Marx	1040
Samsung	1144, 1040
Scientific Atlanta	1008, 1477
Signal	1015, 1040
Signature	1011
Sprucer	1021
StarSight	1422
Starcom	1003, 1015
Stargate	1015, 1040, 1770, 1797

Starquest	1015
TV86	1063
TeleCaption	1221
Teleview	1040
Timeless	1418
Tocom	1012
Toshiba	1000
Tusa	1015
United Cable	1003
Universal	1056, 1191
Viewstar	1063, 1027
Zenith	1000, 1054, 1525
Zentek	1400

DBS TUNER

Manufacturer	Code
AST	2321
Audio Ton	2364
Avalon	2396
Chaparral	2053, 2209
Connexions	2396
DNT	2396
Echostar	2396
Elta	2364
Expressvu	2775
Fuba	2396
Galaxis	2364
Galaxisat	2321
General Instrument	2361
Huth	2364
JSR	2364
JVC	2775
Jerrold	2361
Lemon	2692
NEC	2507
Neusat	2692
Next-Wave	2732
Primestar	2361
Radix	2396
SAT	2321
SatPartner	2692
Seemann	2396
Triad	2321
Wisi	2321, 2396
Zehnder	2321

(DSS)

AlphaStar	2772
Echostar	2775
General Instrument	2869
HTS	2775
Hitachi	2819
Hughes Network System	2749
Jerrold	2627
Magnavox	2724
Memorex	2724

Panasonic	2701
Philips	2724
Primestar	2627
RCA	2566
Sony	2639
Star Choice	2869
Toshiba	2790
Uniden	2724

VCR

Manufacturer	Code
ASA	3037, 3081
Admiral	3048
Adventura	3000
Aiko	3278
Aiwa	3037, 3000
Akai	3041, 3061, 3281, 3288
Akiba	3072
Akura	3271
Alba	3209, 3072, 3278, 3020, 3295
Ambassador	3020
American High	3035
Amstrad	3000, 3278
Anitech	3072
Asha	3240
Asuka	3037
Audiovox	3037
Baird	3000, 3104, 3041
Basic Line	3072, 3278, 3020
Beaumarck	3240
Bell & Howell	3104
Blaupunkt	3162, 3034, 3195, 3226, 3227
Brandt	3187, 3320
Brandt Electronic	3041
Broksonic	3184, 3121, 3209, 3002, 3295, 3361, 3479
Bush	3209, 3072, 3278
CCE	3072, 3278
CGE	3000
Calix	3037
Canon	3035
Capehart	3020
Carver	3081
Catron	3020
Cimeline	3072
Cineral	3278
Citizen	3037, 3278
Clatronic	3020
Colt	3072
Condor	3020
Craig	3037, 3047, 3240, 3072, 3271
Crown	3072, 3278, 3020
Curtis Mathes	3060, 3035, 3041, 3162
Cybernex	3240
Cyrus	3081
Daewoo	3045, 3278, 3020
Dansai	3072
Daytron	3020



De Graaf	3042, 3166	LXI	3037	Portland	3020
Decca	3081, 3000	Lenco	3278	Profitronic	3240
Denon	3042	Leyco	3072	Proline	3000
Dual	3041	Lloyd's	3000, 3208	Proscan	3060, 3202
Dumont	3081, 3000, 3104	Loewe	3037, 3081	Protec	3072
Dynatech	3000	Logik	3240, 3072	Pulsar	3039
ESC	3240, 3278	Luxor	3048, 3104, 3043, 3062, 3046	Pye	3081
Elbe	3038	M Electronic	3000	Quarter	3046
Elcatech	3072	MEI	3035	Quartz	3046
Electrohome	3037	MGA	3240, 3043, 3061	Quasar	3035, 3162
Electroponic	3037	MGN Technology	3240	Quelle	3081
Emerex	3032	MTC	3240, 3000	RCA	3060, 3035, 3048, 3240, 3042, 3202
Emerson	3037, 3184, 3000, 3121, 3043, 3209, 3002, 3278, 3036, 3061, 3068, 3208, 3212, 3295, 3361, 3479	Magnasonic	3278	Radio Shack	3037, 3000
Ferguson	3041, 3320	Magnavox	3035, 3039, 3081, 3000	Radiola	3081
Fidelity	3000	Magnin	3240	Radix	3037
Finlandia	3081, 3104	Manesth	3045, 3072	Randex	3037
Finlux	3081, 3000, 3042, 3104	Marantz	3035, 3081, 3062, 3295	Realistic	3035, 3037, 3048, 3047, 3000, 3104, 3062, 3046, 3066
Firstline	3037, 3045, 3043, 3209, 3072	Marta	3037	Rex	3041, 3384
Fisher	3047, 3104, 3046, 3054, 3066	Matsui	3209, 3036, 3208, 3295	Ricoh	3034
Frontech	3020	Matsushita	3035, 3162	Roadstar	3037, 3240, 3072, 3278
Fuji	3035, 3033	Memorex	3035, 3037, 3048, 3039, 3047, 3240, 3000, 3104, 3162, 3046	Runco	3039
Funai	3000	Memphis	3072	SBR	3081
GE	3060, 3035, 3048, 3240, 3202	Metz	3162, 3195, 3227	SEG	3240
GEC	3081	Minerva	3195	SEI	3081
Garrard	3000	Minolta	3042	STS	3042
General	3020	Mitsubishi	3048, 3081, 3067, 3043, 3061, 3173, 3196	Saba	3041, 3320, 3384
GoldHand	3072	Motorola	3035, 3048	Saisho	3209, 3036, 3208
GoldStar	3037, 3038, 3225, 3471	Multitech	3000, 3072	Salora	3043, 3046
Goodmans	3037, 3000, 3072, 3278, 3062, 3020	Murphy	3000	Samsung	3240, 3045
Gradiente	3000, 3008	NEC	3104, 3067, 3041, 3038, 3040	Sanky	3048, 3039
Graetz	3240, 3104, 3041	Neckermann	3081	Sansui	3000, 3067, 3041, 3271, 3479
Granada	3081, 3104, 3046	Nesco	3072	Sanyo	3047, 3240, 3104, 3046
Grandin	3037, 3000, 3072	Nikko	3037	Schaub Lorenz	3000, 3104, 3041
Grundig	3081, 3072, 3195, 3226	Nikon	3034	Schneider	3081, 3000, 3072
HCM	3072	Noblex	3240	Scott	3184, 3045, 3121, 3043, 3212
HI-Q	3047	Nokia	3240, 3104, 3041, 3046	Sears	3035, 3037, 3047, 3000, 3042, 3104, 3046, 3054, 3066
Hanseatic	3037	Nordmende	3041, 3320, 3384	Seleco	3041
Harley Davidson	3000	Oceanic	3000, 3041	Semp	3045
Harman/Kardon	3038	Olympus	3035, 3226	Sentra	3020
Harwood	3072, 3068	Optimus	3037, 3048, 3104, 3162	Sharp	3048, 3062
Headquarter	3046	Optonica	3062	Shintom	3104, 3072
Hinari	3240, 3072, 3208	Orion	3184, 3121, 3209, 3002, 3036, 3208, 3295, 3479	Shogun	3240
Hitachi	3240, 3000, 3042, 3041, 3166, 3235	Osaki	3037, 3000, 3072	Siemens	3037, 3081, 3104, 3054, 3195
Hypson	3072	Otto Versand	3081	Silva	3037
ITT	3240, 3104, 3041, 3046, 3384	Palladium	3037, 3041, 3072	Singer	3045, 3072
ITV	3037, 3278	Panasonic	3035, 3162, 3225, 3226, 3227	Sinudyne	3081
Imperial	3000	Pathe Cinema	3036	Solavox	3020
Interfunk	3081	Pathe Marconi	3041	Sonolor	3046
JVC	3067, 3041, 3008, 3384	Penney	3035, 3037, 3240, 3042, 3038, 3040, 3054	Sontec	3037
Jensen	3041	Pentax	3042	Sony	3035, 3032, 3000, 3033, 3034
KEC	3037, 3278	Perdio	3000	Sunstar	3000
KLH	3072	Philco	3035, 3209, 3038, 3479	Suntronic	3000
Kaisui	3072	Philips	3035, 3081, 3062, 3384	Sylvania	3035, 3081, 3000, 3043
Kendo	3209	Phonola	3081	Symphonic	3000
Kenwood	3067, 3041, 3038, 3384	Pilot	3037	TMK	3240, 3036, 3208
Kodak	3035, 3037	Pioneer	3081, 3067, 3162, 3235	Tashiko	3000
Korpel	3072			Tatung	3081, 3000, 3041
				Teac	3000, 3041
				Tec	3020



Technics	3035, 3162, 3226
Teknika	3035, 3037, 3000
Teleavia	3041
Telefunken	3041, 3187, 3320, 3384
Tenosal	3072
Tensai	3000
Thomas	3000
Thomson	3041, 3320, 3384
Thorn	3104, 3041, 3036
Toshiba	3081, 3045, 3043, 3041, 3066, 3212, 3366, 3384
Totevision	3037, 3240
Triumph	3208
Uher	3240
Unitech	3240
Universum	3037, 3081, 3240, 3000, 3195
Vector	3045
Vector Research	3038, 3040
Video Concepts	3045, 3040, 3061
Videosonic	3240
Wards	3060, 3035, 3048, 3047, 3081, 3240, 3000, 3042, 3072, 3062, 3212
White Westinghouse	3278
XR-1000	3035, 3000, 3072
Yamaha	3038
Yamishi	3072
Yokan	3072
Yoko	3240, 3020
Zenith	3039, 3000, 3033, 3034

LD PLAYER

Manufacturer	Code
Aiwa	5203
Carver	5064, 5194, 5323
Denon	5059, 5172
Disco Vision	5023
Funai	5203
Hitachi	5023
Magnavox	5194, 5217
Marantz	5064, 5194
Mitsubishi	5059
NAD	5059
Panasonic	5204
Philips	5064, 5194
Pioneer	5059, 5023
Quasar	5204
Realistic	5203
Salora	5064
Samsung	5323
Sega	5023
Sony	5193, 5201
Technics	5204
Telefunken	5059
Theta Digital	5194
Yamaha	5217

Fisher	6179, 6048, 6088, 6342
Garrard	6420, 6393, 6245, 6280, 6425
Genexxa	6032, 6305, 6164, 6426
Goodmans	6305, 6245, 6280
Grundig	6157
Harman/Kardon	6426
Hitachi	6032, 6155
JVC	6072
Kenwood	6028, 6037, 6190, 6048
Kodak	6287
Krell	6157
Kyocera	6018
LXI	6305
Linn	6157
Luxman	6093
MCS	6029, 6043
MTC	6420
Magnavox	6157, 6305
Marantz	6029, 6157, 6180
Matsui	6157
McIntosh	6287
Memorex	6032, 6305, 6155, 6164, 6180
Meridian	6157
Micromega	6157
Mission	6157
Mitsubishi	6156
NAD	6000
NEC	6043
NSM	6157
Nagaoka	6018
Naim	6157
Nakamichi	6147
Nikko	6164, 6170
Onkyo	6101
Optimus	6000, 6032, 6179, 6305, 6037, 6420, 6048, 6145, 6468, 6087, 6280, 6342, 6426, 6437
Panasonic	6029, 6303
Parasound	6420
Philips	6157, 6287
Pioneer	6032, 6305, 6468, 6244
Poppy	6164
Proton	6157
QED	6157
Quad	6157
Quasar	6029
RCA	6179, 6305, 6053, 6155
Realistic	6179, 6420, 6155, 6164, 6180
Revox	6157
Roadstar	6461
Rotel	6157, 6420
Royal	6420
SAE	6157
STS	6018
Sansui	6157, 6305, 6202
Sanyo	6179, 6048, 6087, 6342
Scott	6305, 6155, 6164

DVD PLAYER

Manufacturer	Code
JVC	4558
Kenwood	4534
Magnavox	4503
Mitsubishi	4521
Onkyo	4503
Panasonic	4490
Philips	4503, 4539
Pioneer	4525
Proscan	4522
RCA	4522
Sony	4533
Technics	4490
Toshiba	4503
Yamaha	4490, 4545
Zenith	4503

CD PLAYER

Manufacturer	Code
ADC	6018
Acoustic Research	6420
Adcom	6155
Aiwa	6157, 6012, 6124
Akai	6156
Arcam	6157
Audio Pro	6437
Audio Research	6157
Audio-Technica	6170
Audio Ton	6157
Audiolab	6157
Audiomeca	6157
BSR	6245
Bestar	6164
Burmester	6420
Bush	6245
California Audio Lab	6029
Carver	6157, 6179, 6437
Condor	6164
Crown	6122
Cyrus	6157
DAK	6245
DKK	6000
Denon	6003, 6034
Elektra	6393, 6437
Emerson	6305, 6155, 6164



Sears	6305	Universum	8375
Sharp	6037, 6180, 6261	Victor	8274
Sherwood	6114, 6180, 6426	Wards	8027
Shure	6043	Yamaha	8097, 8094, 8478, 8524
Sony	6000, 6185		
Soundesign	6145, 6425		
Tascam	6420		
Teac	6420, 6393, 6180		
Technics	6029, 6303		
Universum	6157, 6437		
Victor	6072		
Wards	6157, 6053		
Yamaha	6036, 6187, 6261, 6082, 6712		
Yorx	6461		

MD RECORDER

Manufacturer	Code
Kenwood	7826
Sony	7490
Yamaha	7888, 7490

TAPE DECK

Manufacturer	Code
ADC	8171
Aiwa	8029, 8197
Akai	8283
Arcam	8076
Carver	8029
Denon	8076
Fisher	8074
Garrard	8308, 8309, 8375
GoldStar	8375
Grundig	8029, 8375
JVC	8244, 8274, 8303, 8304, 8310
Kenwood	8071, 8092, 8233, 8234
Kyocera	8171
Magnavox	8029
Marantz	8029, 8009
Memorex	8099
Mitsubishi	8283
Onkyo	8136, 8282
Optimus	8027, 8220, 8337
Panasonic	8229
Philips	8029
Phonotrend	8337
Pioneer	8027, 8220, 8099
Revox	8029, 8190
Sansui	8029, 8009
Sanyo	8074
Sharp	8231
Sherwood	8337
Sonic	8375
Sony	8243, 8170, 8291
Teac	8280, 8289, 8308, 8309
Technics	8229





YAMAHA ELECTRONICS CORPORATION, USA 6660 ORANGETHORPE AVE., BUENA PARK, CALIF. 90620, U.S.A.
YAMAHA CANADA MUSIC LTD. 135 MILLNER AVE., SCARBOROUGH, ONTARIO M1S 3R1, CANADA
YAMAHA ELECTRONIK EUROPA G.m.b.H. SIEMENSSTR. 22-34, 25462 RELLINGEN BEI HAMBURG, FR. OF GERMANY
YAMAHA ELECTRONIQUE FRANCE S.A. RUE AMBROISE CROIZAT BP70 CROISSY-BEAUBOURG 77312 MARNE-LA-VALLÉE CEDEX02, FRANCE
YAMAHA ELECTRONICS (UK) LTD. YAMAHA HOUSE, 200 RICKMANSWORTH ROAD WATFORD, HERTS WD1 7JS, ENGLAND
YAMAHA SCANDINAVIA A.B. J A WETTERGRENS GATA 1, BOX 30053, 400 43 VÄSTRA FRÖLUNDA, SWEDEN
YAMAHA MUSIC AUSTRALIA PTY, LTD. 17-33 MARKET ST., SOUTH MELBOURNE, 3205 VIC., AUSTRALIA

YAMAHA CORPORATION
ID V276240